

# JVC



## Mobile mini note PC

---

# MP-XP7230GB/MP-XP5230GB

- Packed together with the MP-XP7230GB are a USB Port Replicator (MP-PRX1GB) and a CD-ROM drive (MP-CDX1E).
- Packed together with the MP-XP5230GB is a CD-ROM drive (MP-CDX1E).

(The operating instructions guide is provided with each item packed.)



## INSTRUCTIONS

Thank you for purchasing the JVC MP-XP7230GB/MP-XP5230GB Mobile mini note PC.

### **Before Use**

Read and follow the instructions of this manual to use your Mobile mini note PC correctly.

Always read the "Safety Precautions" and "Operation Notes." Keep this manual and the warranty card for further reference.

LET0235-002A

**Dear Customer,**

Thank you for purchasing this Mobile mini note PC. Before use, please read the safety information and precautions contained in the following pages to ensure safe use of this product.

Hereby, JVC, declares that this equipment is in compliance with the essential requirements and other relevant provisions of Directive 1999 / 5 / EC.

The modem incorporated in this product was tested according the standard TBR21.

The correct function on a public analogue telephone line and a wireless LAN network is confirmed with the listed cautions.

Should you have any problem on a specific network, we kindly ask you to inform your JVC Service Centre the nature of the problem and details of which service provider you are using.

**It is recommended that you . . .**

.... read thoroughly the Safety Precautions. They contain extremely important information regarding the safe use of this product.

# SAFETY PRECAUTIONS

**WARNING****DANGEROUS VOLTAGE INSIDE**

**WARNING: TO PREVENT FIRE OR SHOCK HAZARD, DO NOT EXPOSE THIS UNIT TO RAIN OR MOISTURE.**

**This unit should be used with 110 – 240 V~, 50/60 Hz only.**

**CAUTION: To prevent electric shocks and fire hazards, do NOT use any other power source.**

**CAUTIONS:**

- To prevent shock, do not open the cabinet. No user serviceable parts inside. Refer servicing to qualified personnel.
- When you are not using the AC Adapter for a long period of time, it is recommended that you disconnect the power cord from the AC outlet.

**NOTES:**

- *The rating plate (serial number plate) and safety caution are on the bottom and/or the back of the main unit.*
- *The rating information and safety caution of the AC Adapter are on the bottom of the adapter.*

**CAUTION:**

To avoid electric shock or damage to the unit, first firmly insert the small end of the power cord into the AC Adapter until it is no longer wobbly, and then plug the larger end of the power cord into an AC outlet.

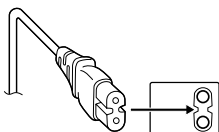

**IMPORTANT** for the U.K.

**DO NOT** cut off the mains plug from this equipment. If the plug fitted is not suitable for the power points in your home or the cable is too short to reach a power point, then obtain an appropriate safety approved extension lead or consult your dealer.

**BESURE** to replace the fuse only with an identical approved type, as originally fitted.

If, nonetheless, the mains plug is cut off be sure to remove the fuse and dispose of the plug immediately, to avoid a possible shock hazard by inadvertent connection to the mains supply.

If this product is not supplied fitted with a mains plug then follow the instructions given below:

**IMPORTANT.**

**DO NOT** make any connection to the terminal which is marked with the letter E or by the safety earth symbol or coloured green or green-and-yellow.

The wires in the mains lead on this product are coloured in accordance with the following code:

Blue : Neutral  
Brown : Live

As these colours may not correspond with the coloured markings identifying the terminals in your plug proceed as follows:

The wire which is coloured blue must be connected to the terminal which is marked with the letter N or coloured black.

The wire which is coloured brown must be connected to the terminal which is marked with the letter L or coloured red.

**IF IN DOUBT - CONSULT A COMPETENT ELECTRICIAN.**

**CAUTIONS:**

- If used near a radio, this unit may interfere with reception.
- Prevent inflammables, water and metallic objects from entering the unit.
- Do not disassemble or modify the unit.
- Do not apply shocks to the unit.
- Do not subject the unit to direct sunlight.
- Avoid using the unit in extremely hot or humid places.
- Avoid using the unit in places subject to vibrations.

**CAUTIONS:**

- This Mobile mini note PC is designed to be used with the JVC BN-LS12E/LL21E battery packs and, to recharge them or to supply power to the Mobile mini note PC from an AC outlet, use the provided AC Adapter and Power Cord. (An appropriate conversion adapter may be necessary to accommodate different designs of AC outlets in different countries.)

When the equipment is installed in a cabinet or on a shelf, make sure that it has sufficient space on all sides to allow for ventilation (10 cm or more on both sides, on top and at the rear).

Do not block the ventilation holes.

(If the ventilation holes are blocked by a newspaper, or cloth etc. the heat may not be able to get out.)

Do not allow the Mobile mini note PC or AC adapter to operate with the base resting directly on anyone's lap. Allowing sustained contact may cause discomfort or, eventually, a burn.

No naked flame sources, such as lighted candles, should be placed on the apparatus.

When discarding batteries, environmental problems must be considered and the local rules or laws governing the disposal of these batteries must be strictly followed.

The apparatus shall not be exposed to dripping or splashing.

Do not use this equipment in a bathroom or places with water.

Also do not place any containers filled with water or liquids (such as cosmetics or medicines, flower vases, potted plants, cups etc.) on top of this unit.

(If water or liquid is allowed to enter this equipment, fire or electric shock may be caused.)

## SOME DO'S AND DON'TS ON THE SAFE USE OF EQUIPMENT

**This equipment has been designed and manufactured to meet international safety standards but, as with any electrical equipment, care must be taken if you are to obtain the best results and safety is to be assured.**

- DO** read the operating instructions before you attempt to use the equipment.
- DO** ensure that all electrical connections (including the mains plug, extension leads and interconnections between pieces of equipment) are properly made and in accordance with the manufacturer's instructions. Switch off and withdraw the mains plug when making or changing connections.
- DO** consult your dealer if you are ever in doubt about the installation, operation or safety of your equipment.
- DO** be careful with the LCD panel on equipment.
- DON'T** continue to operate the equipment if you are in any doubt about it working normally, or if it is damaged in any way — switch off, withdraw the mains plug and consult your dealer.
- DON'T** remove any fixed cover as this may expose dangerous voltages.
- DON'T** leave equipment switched on when it is unattended unless it is specifically stated that it is designed for unattended operation or has a standby mode. Switch off using the switch on the equipment and make sure that your family knows how to do this. Special arrangements may need to be made for infirm or handicapped people.
- DON'T** use equipment such as personal stereos or radios so that you are distracted from the requirements of road safety. It is illegal to watch the LCD panel while driving.
- DON'T** listen to headphones at high volume, as such use can permanently damage your hearing.
- DON'T** obstruct the ventilation of the equipment, for example with curtains or soft furnishings. Overheating will cause damage and shorten the life of the equipment.
- DON'T** allow electrical equipment to be exposed to rain or moisture.

### **ABOVE ALL**

- NEVER let anyone especially children push anything into holes, slots or any other opening in the case — this could result in a fatal electrical shock;
- NEVER guess or take chances with electrical equipment of any kind — it is better to be safe than sorry!

**Mobile mini note PC with Radio Local Area Network (RLAN)****CE 0197** ⓘ**OPERATING AT 2412 TO 2472 MHz**

- This equipment with RLAN is intended to be used in Germany, UK, Austria and Switzerland. Outdoor use may be restricted to certain frequencies and/or may require a licence for operation.

Hereby, JVC, declares that this MP-XP7230GB is in compliance with the essential requirements and other relevant provisions of Directive 1999 / 5 / EC.

**CAUTION**

To reduce the risk of fire, use only No. 26 AWG or larger telecommunication line cord.

**IMPORTANT SAFETY INSTRUCTIONS:**

1. Avoid using a telephone (other than a cordless type) during an electrical storm. There may be a remote risk of electric shock from lightning.
2. Do not use the telephone to report a gas leak in the vicinity of the leak.
3. Use only the power cord and batteries indicated in this manual. Do not dispose of batteries in a fire. They may explode. Check with local codes for possible special disposal instructions.

**When using the wireless LAN****WARNING**

Please heed the warning below.

- Do not turn on the PC's power in trains, aircraft, hospitals or other places where the use of wireless LANs is restricted or prohibited. Use in such places may have an adverse effect on the electronic devices or medical equipment and cause accidents. At present, the policy of airline companies is to prohibit the use of electronic devices in aircraft at certain stages of a flight (take-off and landing). This PC is classified as an "electronic device." For further details, contact the airline companies.

**Radio waves emitted from wireless LANs****WARNING**

Please heed the warning below.

- Do not use the wireless LAN in trains full of passengers and other crowded locations. Wireless LANs emit radio waves which can adversely affect pacemakers and other medical devices.
- Do not use the wireless LAN if you are bringing this PC on board an aircraft or into a hospital. Wireless LANs emit radio waves which may adversely affect measuring instruments and medical equipment.
- Stop using the wireless LAN in this PC if other equipment is being adversely affected by the wireless LAN. Wireless LANs emit radio waves which may adversely affect other equipment and cause accidents triggered by equipment malfunctioning.

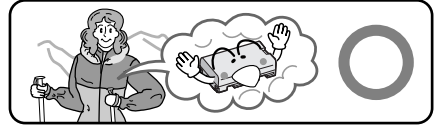
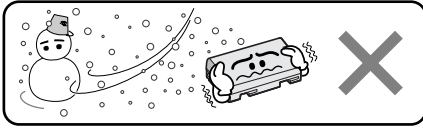

Lithium-ion is vulnerable in colder temperatures.

## About Batteries

**DANGER!** Do not attempt to take the batteries apart, or expose them to flame or excessive heat, as it may cause a fire or explosion.

**WARNING!** Do not allow the battery or its terminals to come in contact with metals, as this can result in a short circuit and possibly start a fire.

**Caution!** Danger of explosion if the battery is incorrectly replaced. Replace only with the same or equivalent type.

### The Benefits Of Lithium-Ion Batteries

Lithium-ion battery packs are small but have a large power capacity. However, when one is exposed to cold temperatures (below 10°C), its usage time becomes shorter and it may cease to function. If this happens, place the battery pack in your pocket or other warm, protected place for a short time, then re-attach it to the Mobile mini note PC. As long as the battery pack itself is not cold, it should not affect performance.

(If you're using a heating pad, make sure the battery pack does not come in direct contact with it.)

# CAUTIONS

## General Battery Precautions

### Use only the following batteries:

Please make note of the following rules for battery use. When misused, the batteries can leak or explode.

1. When replacing batteries, refer to page 16.
2. **Do not** use any different size of batteries from those specified.
3. Be sure to install batteries in the correct direction.
4. **Do not** expose the batteries to excessive heat as they can leak or explode.
5. **Do not** dispose of the batteries in a fire.

.... **do not** modify or disassemble.

.... **do not** expose the battery to temperatures exceeding 60°C, as this may cause the battery to overheat, explode or catch fire.

.... use only specified chargers.

### 2. To prevent damage and prolong service life . . .

.... **do not** subject to unnecessary shock.

.... charge in an environment where temperatures are within the tolerances shown in the chart below. This is a chemical reaction type battery—cooler temperatures impede chemical reaction, while warmer temperatures can prevent complete charging.

.... store in a cool, dry place. Extended exposure to high temperatures will increase natural discharge and shorten service life.

.... fully charge and then fully discharge the battery every 6 months when storing the battery pack over a long period of time.

.... remove from charger or power unit when not in use, as some machines use current even when switched off.

## Battery Packs

The supplied battery pack is a lithium-ion battery. Before using the supplied battery pack or an optional battery pack, be sure to read the following cautions:

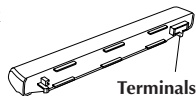

### 1. To avoid hazards . . .

.... **do not** burn.

.... **do not** short-circuit the terminals. When transporting, make sure the provided battery cap is attached to the battery. If the battery cap is misplaced, carry the battery in a plastic bag.

### NOTES:

- It is normal for the battery pack to be warm after charging, or after use.

#### Temperature Range Specifications

Charging ..... 10°C to 35°C

Operation ..... 0°C to 40°C

Storage ..... -10°C to 30°C

- Recharging time is based on room temperature of 20°C.
- The lower the temperature, the longer recharging takes.

# CHECKING INVENTORY

Before using your Mobile mini note PC (hereinafter Mobile PC), make sure that all of the following system components have been included in the container. If you have found any shortage or problem, contact the sales shop.

\* The illustrations provided in these instructions may differ in part from the actual products.

- Mobile mini note PC

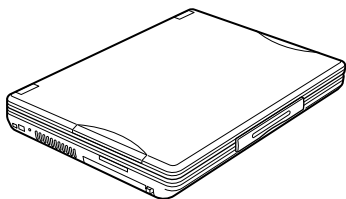

- MP-ACX1E AC power adapter (including dedicated AC cable)

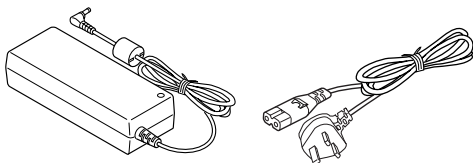

- Modem cable (1.8-meters long)



- Telephone adapter

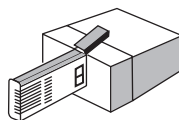

- External display (MP-VGX1E) cable

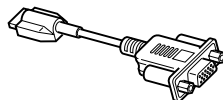

- Lithium ion battery pack

- BN-LL21E Large-capacity (only MP-XP7230GB)
- BN-LS12E standard (only MP-XP5230GB)

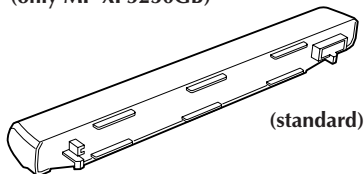

- Two Application CD-ROMs

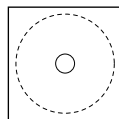

- Two stick caps



- Instruction manual (this book)

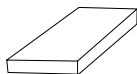

- Protection cover (of battery terminal)

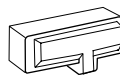

- Warranty card



- Start Here manual

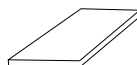

## JVC Software License Agreement

### Important:

Thank you for purchasing JVC Mobile mini note PC ("Product").

Please carefully read this End-User License Agreement ("Agreement") before installing or using JVC original software accompanied with or pre-installed into the Product ("Software"). The right to use the Software is granted by Victor Company of Japan, Limited ("JVC") to You only on the condition that You agree to the following Agreement. If You do not agree to the terms of the Agreement, you may not use the Software any more. Then, please give the Software with the Product back to the dealer from whom you bought the Product. HOWEVER, USING THE PRODUCT OR UNPACKING THE PACKAGED MEDIA CONTAINING THE SOFTWARE INDICATES YOUR ACCEPTANCE OF THESE TERMS AND CONDITIONS.

## END-USER LICENSE AGREEMENT

### 1. Copyright; Ownership

You acknowledge that all copyrights and other intellectual property rights in the Software as well as associated materials such as instruction manual and other documents ("Associated Materials") are owned by JVC and its licensor, and remain vested in JVC and such licensor. The Software is protected under the copyright law of Japan and other countries, and related Conventions.

### 2. Grant of License

- (1) Subject to the conditions of this Agreement, JVC grants to You a non-exclusive right to use the Software.
- (2) You may install and/or use the Software on a HDD or other storage devices incorporated in the Product only.
- (3) You may make a single copy of the Software for the back-up and storage purpose, if a back-up copy of the Software has not been included with the Product on physical media such as CD-ROM. You may use such back-up copy solely for the archival purpose.
- (4) The terms of this Agreement will apply to any updated Software provided by JVC to You at JVC's sole option. Such update will be also deemed as the Software.

### 3. Restriction

- (1) You may not reverse engineer, decompile or disassemble (except to the extent as permitted by the applicable laws) the Software in any manner.
- (2) You may not modify, copy or otherwise dispose of the Software, in whole or in part, other than as expressly specified in this Agreement.
- (3) You have no right to grant a license to use the Software, and may not sell, lease or rent the Software to any other person for any purpose.

### 4. Transfer of the Software

Subject to the fulfillment of the following conditions, You may assign the license granted under this Agreement to other person.

- (1) You assign and transfer such other person the Product including the Software, any copy of the Software contained in the packaged media as well as any Associated Materials, and then will not possess them.
- (2) Such other person as assignee agrees to the Agreement

## 5. Limited Warranty

- (1) THE SOFTWARE IS PROVIDED "AS IS" WITHOUT WARRANTY OF ANY KIND. SHOULD THERE BE ANY PROBLEM ARISING FROM OR CAUSED BY THE SOFTWARE, YOU SHOULD SETTLE ALL SUCH PROBLEM AT YOUR OWN COSTS AND RESPONSIBILITIES.
- (2) THIS SECTION PROVIDES JVC'S EXCLUSIVE WARRANTY REGARDING THE SOFTWARE. JVC DOES NOT MAKE ANY OTHER WARRANTIES, EXPRESS OR IMPLIED.

## 6. Limitation of Liability

JVC WILL HAVE NO LIABILITY WITH RESPECT TO ITS OBLIGATIONS UNDER THIS AGREEMENT OR OTHERWISE FOR CONSEQUENTIAL, EXEMPLARY, INCIDENTAL OR PUNITIVE DAMAGES EVEN IF IT HAS BEEN ADVISED OF THE POSSIBILITY OF SUCH DAMAGES. YOU WILL INDEMNIFY AND HOLD HARMLESS JVC FROM ANY LOSS, LIABILITY OR COSTS ARISING OUT OF OR IN ANY WAY CONNECTED TO CLAIMS FROM ANY OTHER PERSONS RELATING TO THE USE OF THE SOFTWARE.

## 7. Term

This Agreement will become effective on the date when You start to use the Product or You unpack the packaged media containing the Software, whichever become earlier, and continue to be in effect until termination under Section 8 below.

## 8. Termination

- (1) Should You breach any provision of this Agreement, JVC may terminate this Agreement without giving any notice to You. In this event, JVC may claim against You any damages caused by Your breach.
- (2) Should this Agreement be terminated, You should immediately destroy the Software including any copy (including erasure from any memory in the Product) and any associated Materials, and then will not possess them.

## 9. Export Control

You agree that You will not ship, transfer or export the Software or underlying information and technology to any countries to which Japan and other relevant countries have embargoed goods.

## 10. General

- (1) No modification, change, addition, deletion or other alteration of or to the Agreement will be valid unless reduced to writing and signed by an authorized representative of JVC.
- (2) Even if any part of the Agreement is held invalid by or in conflict with any law having jurisdiction over this Agreement, the remaining provisions will remain in full force and effect.
- (3) To the maximum extent permitted by the applicable law where the Software was acquired, any conditions or warranties imposed or implied by law are hereby excluded. You may nevertheless have the benefit of certain rights or remedies pursuant to the applicable law in respect of which liability may not be excluded. In any case, however, JVC's entire liability will be limited to those which apply to the Product.
- (4) The Agreement shall be governed by and interpreted under the laws of Japan. The Tokyo District Court has jurisdiction over all disputes which may arise with respect to the execution, interpretation and performance of this Agreement.



## END-USER LICENSE AGREEMENT

### **Important:**

Please carefully read this End-User License Agreement ("Agreement") before installing or using the G.726 Decoder ("Software") on your PC. The right to use the Software is granted by Victor Company of Japan, Limited ("JVC") to You only on the condition that You agree to the following Agreement. If You do not agree to the terms of the Agreement, you may not install the Software any more. HOWEVER, INSTALLING OR USING THE SOFTWARE INDICATES YOUR ACCEPTANCE OF THESE TERMS AND CONDITIONS. The Software also includes the associated materials, and any modification, upgrade and update of the Software granted to You by JVC.

### **1. Copyright; Ownership**

You acknowledge that all copyrights and other intellectual property rights in the Software is owned by, and remain vested in Sharp Corporation, a Japanese corporation, and JVC is the authorized licensee of Sharp Corporation to duplicate, use and distribute the Software. The Software is protected under the copyright law of Japan and other countries, and related Conventions. You must use the Software in the same manner as You use any other copyrighted work in compliance with these laws and conventions and other regulations.

### **2. Grant of License**

- (1) Subject to the conditions of the Agreement, JVC grants to You a non-exclusive right to use the Software.
- (2) You may install and use the Software in Your PC.
- (3) You may make a copy of the Software in whole or in part for the back-up and storage purpose.

### **3. Restriction**

- (1) You may not modify, reverse engineer, decompile or disassemble (except to the extent as permitted by the applicable laws) the Software in any manner.
- (2) You may not copy or use the Software, in whole or in part, other than as expressly specified in this Agreement.
- (3) You may not remove the copyright and/or other proprietary rights notice from the Software. You may make copies of the Software hereunder, provided that each such copy contains copyright and/or other proprietary rights notice in the same manner as appeared originally on this Agreement and the Software.
- (4) You have no right to grant a license to use the Software, and may not sell, lease or rent the Software to any other person for any purpose.

### **4. Transfer of the Software**

You may not transfer or assign the Software (either stored in the recording media or not) to any other person, unless such other person as the transferee or assignee agrees to this Agreement. Such assignee or transferee will be bound by the same conditions as provided for in this Agreement, and the license originally granted to You hereunder will then be null and void.

### **5. Limited Warranty**

THE SOFTWARE IS PROVIDED "AS IS" WITHOUT WARRANTY OF ANY KIND. JVC DOES NOT MAKE ANY OTHER WARRANTIES, EXPRESS OR IMPLIED, INCLUDING BUT NOT LIMITED TO WARRANTIES OF MERCHANTABILITY OR FITNESS FOR A PARTICULAR PURPOSE. SHOULD THERE BE ANY PROBLEM ARISING FROM OR CAUSED BY THE SOFTWARE, YOU SHOULD SETTLE ALL SUCH PROBLEMS AT YOUR OWN COST AND RESPONSIBILITY.

## 6. Limitation of Liability

JVC WILL HAVE NO LIABILITY WITH RESPECT TO ITS OBLIGATIONS UNDER THIS AGREEMENT OR OTHERWISE FOR CONSEQUENTIAL, EXEMPLARY, INCIDENTAL OR PUNITIVE DAMAGES EVEN IF IT HAS BEEN ADVISED OF THE POSSIBILITY OF SUCH DAMAGES. YOU WILL INDEMNIFY AND HOLD HARMLESS JVC FROM ANY LOSS, LIABILITY OR COSTS ARISING OUT OF OR IN ANY WAY CONNECTED TO CLAIMS FROM ANY OTHER PERSONS RELATING TO THE USE OF THE SOFTWARE.

## 7. Term

This Agreement will become effective on the date when You download and/or install the Software onto Your machine, and continue to be in effect until termination under the reasons as below:

Should You breach any provision of this Agreement, JVC may terminate this Agreement without giving any notice to You. In this event, JVC may claim against You any damages caused by Your breach. Should this Agreement be terminated, You should immediately destroy the Software stored in Your machine (including erasure from any memory in Your PC), and then will not possess such Software.

## 8. Export Control

You agree that You will not ship, transfer or export the Software or underlying information and technology to any countries to which Japan and other relevant countries have embargoed goods.

## 9. Restricted Rights Legend

The Software including related documentation has been developed at private expense of Sharp Corporation, and is commercially available.

If the Software is acquired by You under a United States Department of Defense contract, the use, duplication or disclosure by the Government is subject to the restrictions as set forth in subparagraph (c)(i)(ii) of the Rights in Technical Data and Computer Software clause at DFARS 252.227-7013. Contractor: Victor Company of Japan, Limited, 12, 3-chome, Moriya-cho, Kanagawa-ku, Yokohama, Kanagawa 221-8528 Japan.

If the Software is acquired by You as any other agency of the U.S. Government, the use, duplication, or disclosure by the Government is subject to the restriction as set forth in subparagraph (g)(3) of FAR 52.227-14 or FAR 52.227-19, as applicable.

## 10. General

- (1) No modification, change, addition, deletion or other alteration of or to the Agreement will be valid unless reduced to writing and signed by an authorized representative of JVC.
- (2) To the maximum extent permitted by the applicable law where the Software was acquired, any conditions or warranties imposed or implied by law are hereby excluded. You may nevertheless have the benefit of certain rights or remedies pursuant to the applicable law in respect of which liability may not be excluded. In any case, however, JVC's entire liability will be limited to those which apply to your Mobile mini note PC.
- (3) Even if any part of the Agreement is held invalid by or in conflict with any law having jurisdiction over this Agreement, the remaining provisions will remain in full force and effect.
- (4) The Agreement shall be governed by and interpreted under the laws of Japan. The Tokyo District Court has jurisdiction over all disputes which may arise with respect to the execution, interpretation and performance of this Agreement.

## Table of contents

SAFETY PRECAUTIONS .....	2	<b>HARDWARE</b>	
SOME DO'S AND DON'TS ON THE SAFE		Using the Pointing Device .....	52
USE OF EQUIPMENT .....	3	Using Hot Keys .....	54
WHEN USING THE WIRELESS LAN .....	4	Using the Numeric Keypad .....	54
RADIO WAVES EMITTED FROM		If a key top has come off .....	55
WIRELESS LANS .....	4	Increasing the (Optional) Memory	
CAUTIONS .....	5	Capacity .....	56
CHECKING INVENTORY .....	6	Adding or Removing a Memory Board .....	57
JVC Software License Agreement .....	7	Checking the Additional Memory Board .....	59
END-USER LICENSE AGREEMENT .....	9	Using the SD Memory Card Slot .....	60
PARTS AND COMPONENT NAMES .....	12	Using an External Monitor .....	61
		Connecting to a network .....	63
<b>SETTING UP</b>		Setting for network connection .....	63
SETTING UP .....	16	General description of wireless LAN .....	67
TURN-ON .....	19	Types of wireless LAN networks .....	67
Turning <b>ON/OFF</b> (On/Off) Key ON .....	19	Suggestions for using the wireless LAN .....	68
Initial Setup of Microsoft Windows .....	20	Setup procedure for the wireless LAN .....	68
Turn-OFF .....	22	How to shut down the wireless LAN functions ...	75
		Checking the battery level .....	76
<b>JVC ORIGINAL SOFTWARE AND</b>		Power-saving mode .....	77
<b>SYSTEM APPLICATIONS</b>		Unknown partition on hard disk .....	79
JVC ORIGINAL SOFTWARE .....	24		
Setup of JVC Original Software .....	24	<b>PC RECOVERY (REPEATED PC SETUP)</b>	
DVC's USB Drivers .....	25	Setting Up Your PC Again .....	82
CC Converter .....	27	Before starting the repeated PC setup .....	82
		System Recovery Procedure .....	83
STANDARD APPLICATION .....	30		
To set Up the Standard Applications		<b>TROUBLESHOOTING</b>	
Again .....	32	Q&A .....	86
To Uninstall a Standard Application .....	32	Power .....	86
		Startup and Operation of Windows .....	87
<b>NAVIGATE IN THE INTERNET WORLD!</b>		Display .....	89
TO CONNECT TO THE INTERNET .....	34	Using the Internet .....	90
Contracting with the Internet		Wireless LAN .....	93
Service Provider .....	34	Battery .....	94
Connection of Telephone Line and		SD memory cards .....	95
Modem Setup .....	35	USB Port .....	95
The Internet Connection Setup .....	37	Miscellaneous .....	96
Connecting to the Internet .....	42		
Disconnection from the Internet .....	43	<b>APPENDIX</b>	
Accessing a Web Page .....	44	List of Support Centres .....	100
E-MAILING .....	45	Trademark notice .....	101
Setting up E-Mail Software .....	45	Specification .....	102
Sending and Receiving E-mails .....	48	Wireless LAN specifications .....	103
		Options (separately available) .....	104

## PARTS AND COMPONENT NAMES

Your Mobile PC has the following parts and components.

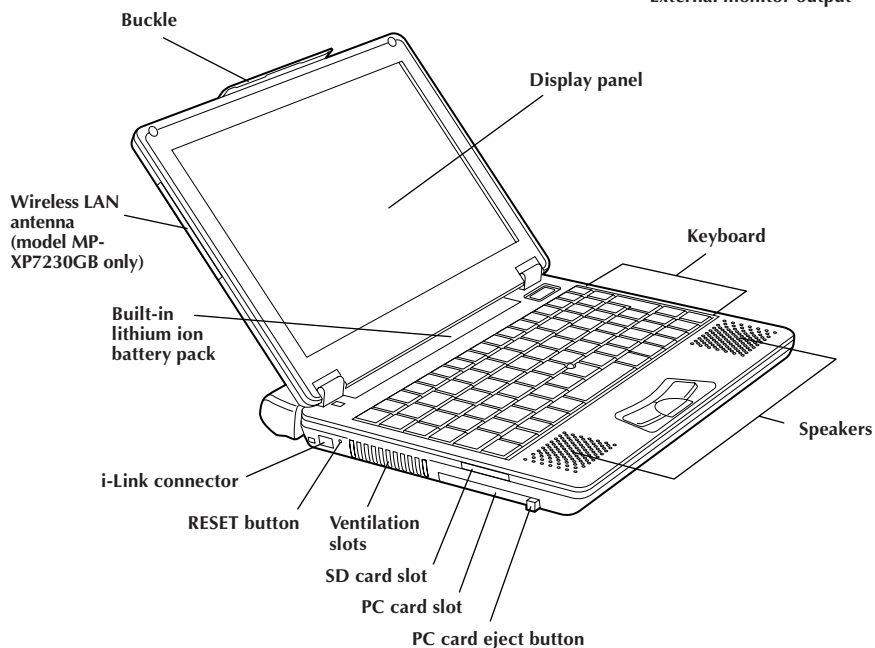
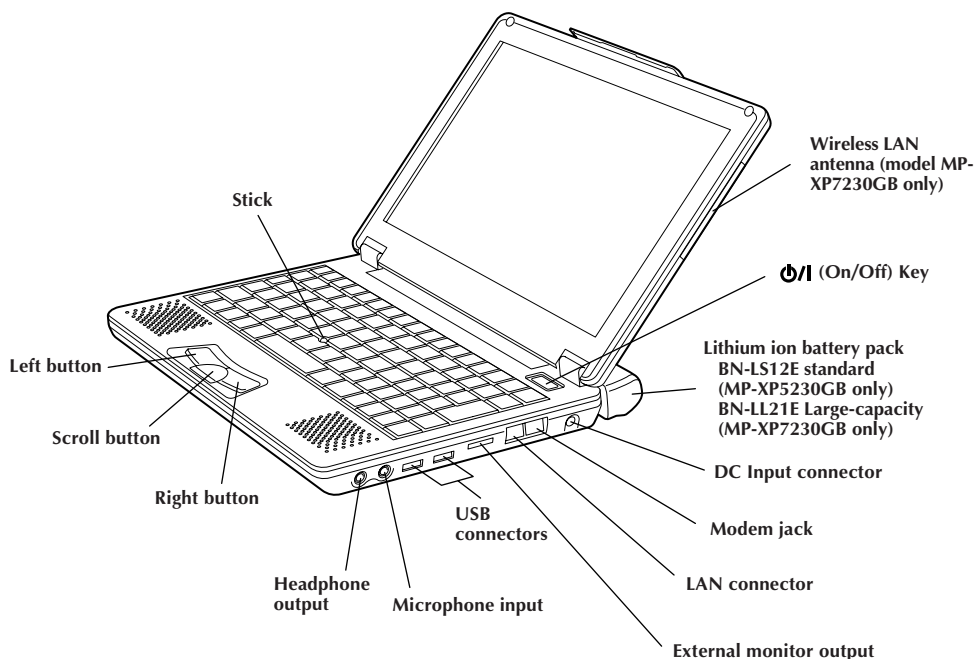

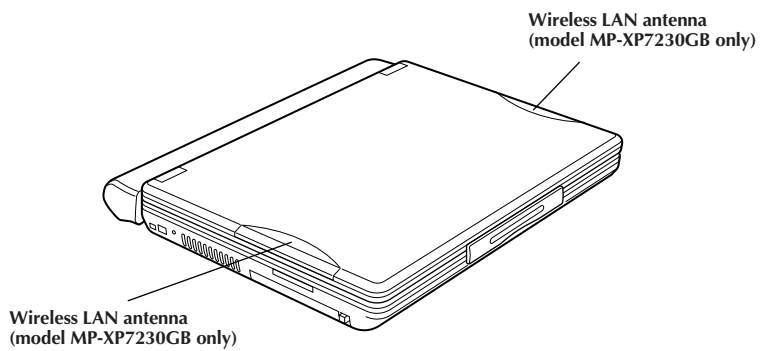





# SETTING UP

## SETTING UP

When you first use your Mobile PC, always plug the AC power cord into the DC Input connector. The built-in lithium-ion battery pack will be recharged during your PC setup. To avoid data loss due to power failure or any others cause, check the points for battery recharging in Page 18.

### 1. Unplug the jumper pin before recharging the battery pack

Always unplug the battery terminal jumper pin from the PC rear panel when recharging the battery pack by plugging the AC power cord into the DC Input connector.

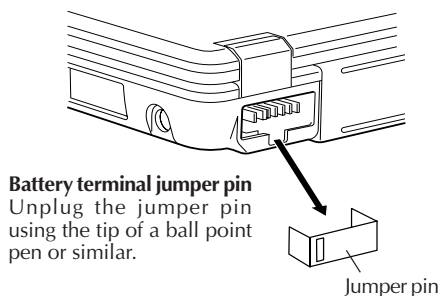

(The jumper pin is factory-mounted to disconnect the battery pack from the circuitry. The removed pin is not used again.)

#### Tips

Cover the battery terminal with the protection cover of accessory kit if you use the Mobile PC without using the standard lithium ion battery pack or the optional large capacity lithium ion battery pack.

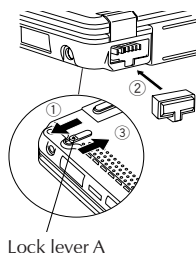

#### Mounting the Protection Cover

- ① Slide lock lever A mounted at the bottom of the Mobile PC in the direction of the arrow.
- ② Mount the battery terminal protection cover.
- ③ Slide lock lever A in the direction of the arrow until it locks.

### 2. Mounting/Dismounting the Lithium Ion Battery Pack

#### • Mounting Battery Pack

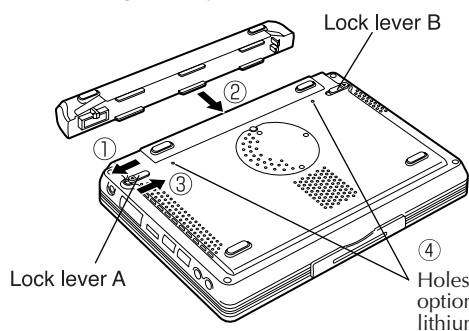

- ① Slide lock lever A in the direction of the arrow (outward).
- ② Mount and lock the battery pack until it clicks.
- ③ Slide lock lever A in the direction of the arrow (inward).
- ④ Tighten two coin screws (when the large capacity lithium ion battery pack is used).

#### • Dismounting Battery Pack

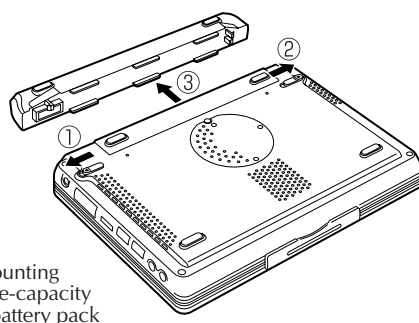

- ① Slide lock lever A in the direction of the arrow.
- ② Slide and hold lock lever B in the direction of the arrow, and pull out and dismount the battery pack in direction ③ as shown.



### 3. Open the display panel

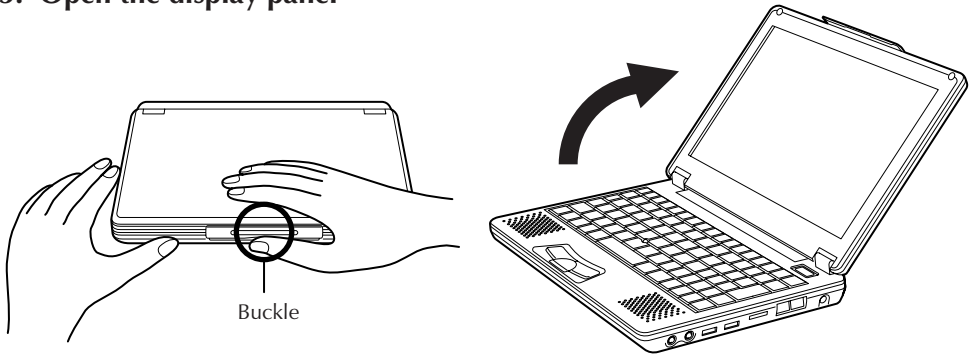

- ① Slightly pull up the buckle of the Note PC, and the display panel will be unlocked.
- ② Carefully open the display panel to the desired angle. You can open the display panel to 180 degrees.

### 4. Recharge the built-in battery pack by plugging the AC cord into DC Input connector

When recharging the built-in battery pack:

- ① Plug the AC power cord into the AC adapter.
- ② Plug the DC cord of the adapter into the DC Input connector of the Mobile PC.
- ③ Plug the AC cord of the AC adapter into the power receptacle.

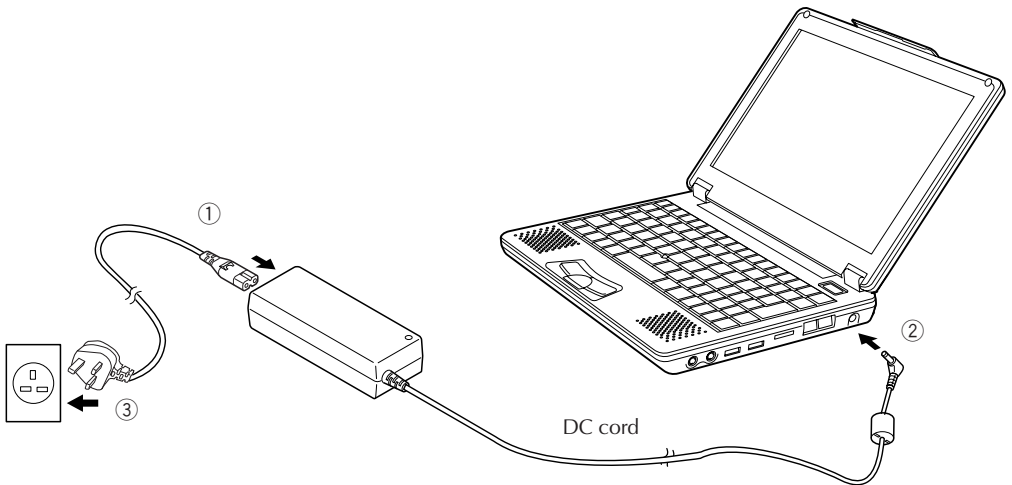



## 5. Make sure that the battery pack is fully charged

To avoid an interruption of your operation due to power failure, check the battery voltage when you start to use your PC in the field. See "Checking the battery level" (see Page 76) to check the battery voltage level.

### • Make sure that the battery pack is fully recharged

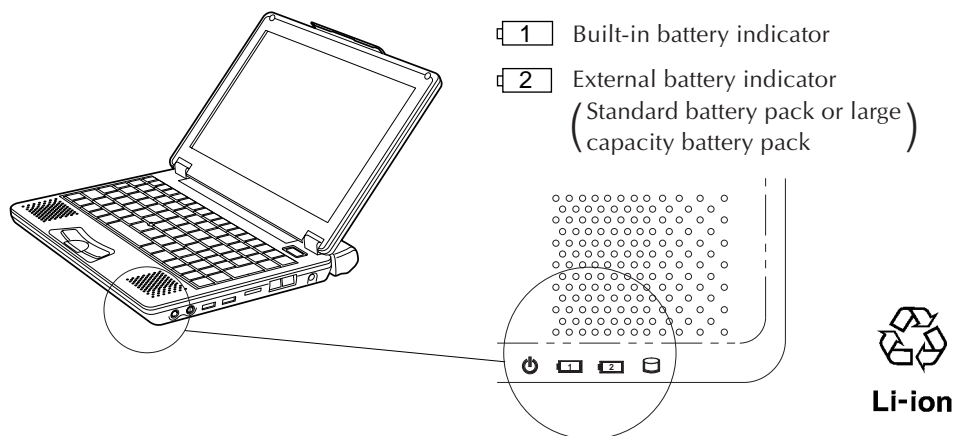
When you are using the AC adapter and when the battery indicator (  ) lights in green, the battery pack is fully (100%) recharged. When it lights in orange, the battery pack is being recharged. Battery recharge starts with the built-in battery or external battery pack, whichever has less remaining power.



If you have unplugged the DC cable of the AC adapter and if you drive your PC with the lithium battery pack, the battery indicator (  ) goes out.

### Approximate recharging times (when the PC's power is off) :

	80% recharging time	100% recharging time
Built-in battery pack	Approximately 60 minutes	Approximately 90 minutes
Both built-in battery pack and BN-LS12E standard battery pack	Approximately 170 minutes	Approximately 250 minutes
Both built-in battery pack and BN-LL21E large capacity battery pack	Approximately 240 minutes	Approximately 370 minutes

### Cautions

- If the battery pack is discharged quickly even after its recharging, the battery service life has expired. Replace it with a new one. (The built-in battery pack and CMOS backup cells are service parts.)
- The standard recharging times listed above are typical values in an ambient temperature of 20°C to 25°C.
- It may take up to 1.5 times longer to recharge the battery pack if the PC is being used.

# TURN-ON

## Turning (On/Off) Key On

Press the  (On/Off) key.



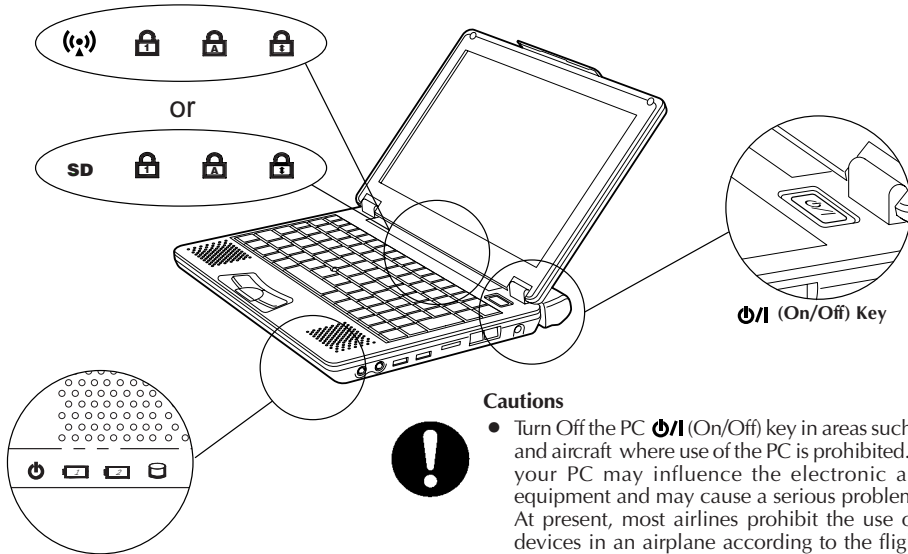



The PC will turn on and the Windows logo will appear.



### Cautions

- Turn Off the PC  (On/Off) key in areas such as hospitals and aircraft where use of the PC is prohibited. Otherwise, your PC may influence the electronic and medical equipment and may cause a serious problem. At present, most airlines prohibit the use of electronic devices in an airplane according to the flight condition (taking off and landing) of the aircraft and others. This machine is also grouped in these electronic devices. Consult each airline for details.

### • Status indicators

	Stand By lamp	When the PC is turned on	Lights up green.
	HDD access lamp	When the HDD is accessed	Lights up green.
* 	Wireless LAN access lamp (model MP-XP7230GB only)	When wireless LAN is accessed	Lights up orange.
<b>SD</b>	SD access lamp (model MP-XP5230GB only)	When the SD card is accessed	Lights up green.
	Num Lock lamp	When the Num Lock key is active	Lights up green.
	Caps Lock lamp	When the Caps Lock key is active	Lights up green.
	Scroll Lock lamp	When the Scroll Lock key is active	Lights up green.

\* This lamp flashes while the access point, etc. is being searched.

### Cautions

Disconnect all peripheral devices (such as a telephone or printer) when you press the  (On/Off) key first. Otherwise, your PC setup may fail.

## Initial Setup of Microsoft Windows

When using your PC for first time, you must prepare to use Microsoft Windows. Once you have finished the initial Windows setup, you can use the software and various PC functions. Use the following procedure to initially set up Microsoft Windows. For pointing device and keyboard operations, see Pages 52 to 54.

### 1. When the "Welcome to Microsoft Windows" screen appears, click [Next] at the right lower corner of the screen.

The "The End User License Agreement" screen will appear.

### 2. Read the "The End User License Agreement" information and click "Yes, I accept it" option if you accept the agreement. Then, click [Next].

The "what's your computer's name?" screen will appear.

#### Note

If you select the "No, I don't accept it" option, the initial Windows setup is cancelled. You cannot use the Microsoft Windows and the PC software.

### 3. Rename your computer and click [Next].

The "An Internet connection could not be chosen" screen appears.

#### Tips

A unique computer name is required so that your PC is distinguished from other computers if you connect your PC to the network. Although the PC is named automatically and shown in the "Computer name" column, you can change it to a name which is easy to remember.

### 4. Click [Next].

The "Ready to register with Microsoft?" screen appears.

### 5. Click "No, not at this time" option, and click [Next].

The "who will use this computer?" screen may appear.

#### Tips

If you select "Yes, I'd like to register with Microsoft now" option, you can start online user registration. For Internet connection setup, see Page 34 "To Connect to the Internet" section.

## 6. Enter the user name and click [Next].

The "Thank you!" screen will appear.

### Tips

The name you have entered is shown on the "welcome" screen that appears when you turn the PC power switch on after initial Windows setup. To start up Microsoft Windows, click the user name shown on the screen.

## 7. Click [Finish].

The initial Windows setup has completed.

### Cautions

- No guarantees are made for operation if an operating system other than the one already installed in your PC is installed.
- When a week has passed after initial startup of the Microsoft Windows, a confirmation screen asking for the deletion of desktop icons appears. This is the Desktop Cleanup program that can delete icons that you have not used for a certain period from the desktop screen. The software is not deleted even if you have cleared its icon from the desktop screen.
- Use the following procedure to change the Windows date and time.
  1. Double-click the time display in the task tray at the lower right of the desktop. The "Date and Time Properties" dialog box appears.

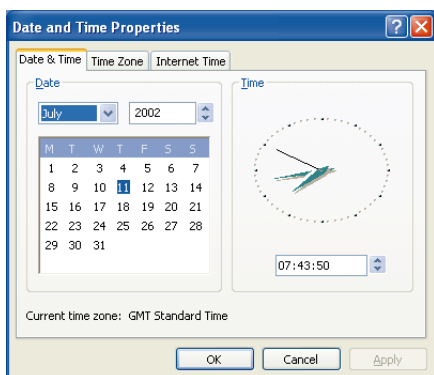

2. Click the "Time Zone" tab and select your time zone from the list box.
3. Click the "Date & Time" tab and enter the correct date and time.
4. Click "OK" to save your change.

## Turn-Off

### Cautions

- Always use this procedure to turn off the PC. Otherwise, your PC may fail.

#### 1. Click [start].



The "start" menu will appear.

#### 2. Click [Turn Off computer].

The "Turn off computer" screen will appear.

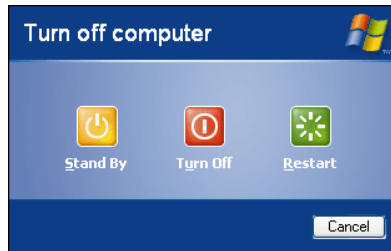
#### 3. Click [Turn Off].



The PC will be turned off automatically, and  (Stand By) lamp will go out. Before closing the LCD panel, make sure that  (Stand By) lamp has turned off.

### Tips

To restart Windows without turning off the power, click [Restart] on the "Turn off computer" screen. Alternatively, press the [Shift] button on the keyboard while "Turn off computer" screen is displayed. The screen below will appear and the PC can be put into [Hibernation].

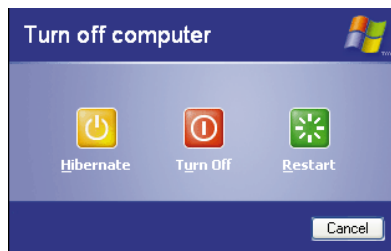

For details on the [Standby] and [Hibernation] modes, refer to pages 77 and 78.

# 2

## JVC ORIGINAL SOFTWARE AND SYSTEM APPLICATIONS

## JVC ORIGINAL SOFTWARE

To use the JVC original software, you must set it up in the "Original Software Setup Procedure" given below. You can setup the following software programs.

### Setup software

- CC converter (See Page 27.)
- JVC's DVC (Digital Video Camera) utilities

### Tips

- The JVC's DVC utilities are USB drivers dedicated to GR-DV4000EK, DV3500EK, DV3000EK, DV2000EK, DV700EK, DV600EK, DV500EK, DV400EK, DX300EK, DX100EK, DX95EK, DX75EK, DX70EK, DX60EK, DX55EK, DX35EK, DX25EK, DV70EK, DV60EK, D50EK, D40EK, DVP9EK, DVP8EK, DVP7EK and DVP3EK systems. If you are using any of these DVC's, you can use it without uploading its USB driver from the DVC's CD-ROM disk.
- For DVC connection and operations, see its instruction manual.

## Setup of JVC Original Software

Before starting the software setup, quit and save the currently active application if any. Otherwise, your working data will be lost.

### 1. Click [start] and click [Run first] at the right lower end of the Menu.

The "Preparing to Install..." screen will appear, and the software setup will start up.

### 2. Read the License Agreement when displayed.

If you accept the Agreement, click [Yes]

### 3. During setup, the "Sound, video and game controllers has not passed Windows Logo testing to verify its compatibility with Windows XP." message may be displayed. Ignore it as it does not affect the system operation. Click [Continue Anyway] to continue software setup.





4. When the software has been set up, a prompt for PC restarting appears. Click [Finish] to restart the PC.

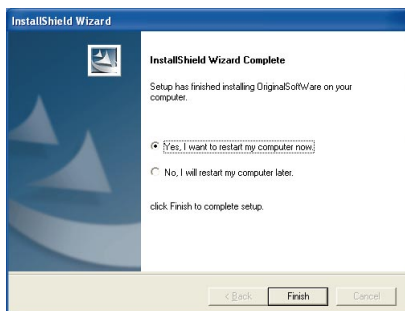

### Cautions

This setup cannot install all DVC utilities.

After you have set up the original software, plug the DVC cable into the USB socket of your PC. The device type will be recognized automatically and setup of its USB driver will start up.

## DVC's USB Drivers

The DVC connection and the USB driver to be set up vary depending on the DVC model you use. For details, see the DVC instruction manual.

1. Connect the DVC to the USB connector of your PC.
2. The hardware installation screen will appear.
3. Select the "Install the software automatically" option and click [Next].

### Cautions

- The driver to be set up depends on the DVC operation mode.
- There is no operation problem although the "has not passed Windows Logo testing..." message appears.

- 1) If "The hardware: JVC DV Camera Storage" message appears:

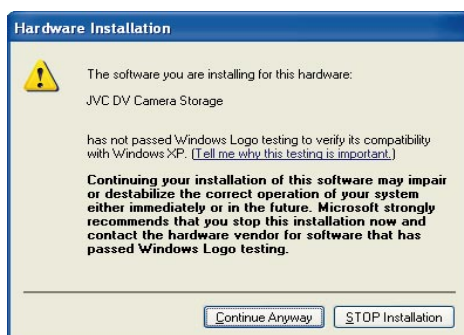

- ① Click [Continue Anyway].
- ② The driver will be installed automatically.
- ③ When "Completing the Found New Hardware Wizard" message appears, click [Finish].

2) If "The hardware: JVC Web Camera" message appears:



- ① Click [Continue Anyway].
- ② The driver will be installed automatically.
- ③ When "Completing the Found New Hardware Wizard" message appears, click [Finish].

### Cautions

As your PC has two USB ports, you need to set up both of them if you use them. If you are prompted to set up the USB port when you attach a device to it, repeat the above procedure again.

## CC Converter

This is a data-band expansion system JVC has developed for audio applications. It reproduces the timbre of the original sound from high-quality and compressed music data as well.

The CC converter operates as a system filter so that it takes effect regardless of the playback application.

### To make the effect valid or invalid or to change the effect level:

1. Open a shortcut of  (CC Converter) icon in the task tray (by clicking the right mouse button).

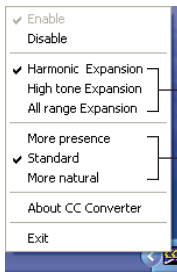

About the expansion effect modes  
(see next page for details)

About the intensity  
(see next page for details)

2. When the menu above appears, click on the desired option.

### Cautions

- If you have disabled the effect, the CC Converter icon is shown in monochrome color in the task tray.
- The actual sound playback may slightly be delayed due to processing of playback data.

### Explanation of menu options

- **Enable**

Makes the CC converter processing valid.

- **Disable**

Makes the CC converter processing invalid.

The following menu options are effective only when you have checked the "Enable" option.

### About the expansion effect modes

One of the following three effect modes can be selected.

Each has its own special characteristics as described below depending on the frequency band pattern which is to be expanded.

- **Harmonic expansion mode**

Expanding the harmonic components contained in music accentuates the lingering tones and gives the sound an added brilliance. This mode is particularly suited to vocals and music made by acoustic instruments. It can have an effect on almost all genres of music, and it is the mode which is normally used.

- **High-range expansion mode**

Expanding the high-range components enhances the feeling of the sound's resolution. It is particularly suited to hard-sounding types of music made by electronic instruments. With rock or pop music, you can enjoy a more lively sound.

- **All-range expansion mode**

This provides an expansion effect over the all range contained in the music. Since there is no focus on a particular point to be expanded, the CC converter can have an effect with all types of music.

### About the intensity

One of three menu options can be selected as the intensity level of the effect to be exerted by the CC converter. It is recommended that you select the level of intensity that matches the size of the speakers that will reproduce the sound, the performance of the headphones and type of sound data (compressed or non-compressed).

- **More presence**

The CC converter functions to have the maximum effect.

The "More presence" level is suited to playing back compressed music data through the PC's built-in speakers or other small-sized speakers. With some types of music, the noise may be accentuated in which case the "Standard" or "More natural" option should be selected.

- **Standard**

With the "Standard" level, the CC converter exerts an effect which is suited to listening to compressed music data through headphones or mini audio components. This is the setting which is normally used.

- **More natural**

The CC converter functions to reproduce the original sound with the highest possible fidelity. The "More natural" level is suited to listening to non-compressed high-quality data through large-sized speakers.

- **About CC converter**

Shows the CC converter version and other information.  
Click [OK] to close the displayed subwindow.

- **Exit**

Quits the CC converter. The CC converter status you have set at this point is held. If you wish to restart the CC converter, you can start up the program from the Start menu.

### **Cautions**

- Do not change the sound playback device when you are playing back the sound data (such as an audio file).
- If you have changed the sound playback device, wait five (5) or more seconds before playing back the data.
- The CC converter can process two-channel PCM data only. A sound device may transfer multi-channel data or non-PCM data, but the CC converter cannot process such data.
- If you play back data having a high noise level, the noise may be emphasized.
- Users other than the computer administrator (even if they have the Administrator's authority) may not change the CC converter setup.

## STANDARD APPLICATION

---

Your Mobile PC has the following standard applications. Open the Help menu of each application to check the application usage. If you have any question, contact the nearest support centre listed on Page 100.

- **Acrobat Reader 5.1**

- **Can display and print out a PDF file.**

- Using the Acrobat Reader, you can display and print out a PDF format file.

- **Norton AntiVirus 2003**

- **The software to prevent virus infection from the Internet.**

- This is the highly reliable antivirus program. It can automatically restore your system from virus infection without interrupting your current works. This program prevents the spread of viruses as it checks for virus infection during e-mail reception and transmission. Also, it can prevent the script-based virus infection even if you have not yet updated it to the latest antivirus definition.

- **Cautions**

- At the third startup after the Windows initial setup, a Norton AntiVirus Information Wizard screen appears. Follow the on-screen instructions to set up this application program.
    - You can update the antivirus definition file of this application within 90 days.

- **ImageMixer with VCD 1.1 VJ**

- **Can edit an original movie.**

- You can pick up movie pictures using a digital video camera (DVC) and edit them by using the effects when you switch the scene, inserting a still image, and adding after-recording sound and BGM.

- The edited movie is recorded in the MPEG1 format, and its file size is smaller than the DV format file. You can distribute the movies to your friends to enjoy the camcorder playback. Furthermore, Video CDs can easily be created from MPEG1 data so that images of cherished memories can be reproduced on the TV screen or PC screen.

- **Cautions**

- For communication using the USB connection, this software is supported by JVC's digital video camera with the GR-DVP9EK and later model numbers. (It is also supported by old model numbers i.Link is used for communication.)
    - The functions for creating DVD Videos are supported if they are updated. (A fee will be charged for the updating facility.)
    - As this software is a hybrid application, read the items relating to the Windows OS when you check the Help menu.

- **Real Player 8 Basic**

- **Can play back a video file.**

- The Real Player can play back some video files not supported by the Windows Media Player (included in the Windows XP OS).

- **Pinnacle Studio 8 SE (only MP-XP7230GB)**

**The video editing software for the broadband age.**

This software makes it possible to capture moving pictures or still pictures from a digital video camera or digital camera, add various video effects and output them to a digital video camera or create movies in a variety of formats.

The software comes with authoring and writing functions for DVDs, VCDs and SVCDs so that finished movies can be viewed on a home-use DVD player, for instance.

**Notes:**

- With Pinnacle Studio 8 SE which is supplied with this PC, frame loss may occur in the created moving images when transitions (editing function effects) are inserted.
- Red is set as the standard color used for the decorative characters when titles are created. (The color can be changed using a setting.)

**Cautions**

- Depending on the power management setting, the sound may break up in places while an application using a USB Audio device is being executed. To use an application like this, select **[Control Panel] → [Performance and Maintenance] → [Power Options]**, and then select **[Always On]** as the power scheme setting. Since the power management functions are restricted and the life of the battery during its use is shortened when this setting is selected, it is recommended that the original setting be restored after exiting the application.

## To Set Up the Standard Applications Again

You can set up the standard applications using the Application CD-ROM. (The optional CD-ROM drive is required.)

If you have erroneously deleted any of the standard applications, you can reinstall it from the Application CD-ROM. For details, see the "readme.txt" file in the Application CD-ROM.

### Warning



- Use the standard CD-ROMs on the CD-ROM drive only. Otherwise, your ears or speaker system may be damaged due to loud noise.

## To Uninstall a Standard Application

Use the following procedure to uninstall a standard application program.

1. Click the [start] button, then [Control Panel].
2. Click the [Add or Remove Programs] icon.  
The programs currently installed are listed.
3. Click an application program you want to uninstall. Click the [Change/Remove] button.
4. When you see a "Are you sure you want to remove ...?" message, click [Yes].
5. The uninstaller will remove the selected application program.





## **NAVIGATE IN THE INTERNET WORLD!**

## TO CONNECT TO THE INTERNET

---

You must contract with an Internet service provider. Also, you need to have a telephone line to be connected to the service provider.

### Contracting with the Internet Service Provider

An Internet service provider (an enterprise or an organization that provides the Internet connection and related services) is generally called a "provider."

- **Contract with the provider**

Get the information about the sign-up to the provider, connection fee, service contents and other information from an Internet magazine.

We recommend that you compare available services and select the provider that best fits your needs.

- **If you have already contracted with a provider**

You can use your provider accounts (such as user ID and password) on your PC.

- **When you have contracted with a provider**

You will receive a document showing your user ID, password and e-mail address. Keep this document to hand when you set up the Internet connection.

#### **Caution**

- You may need a credit card when contracting with some providers.

## Connection of Telephone Line and Modem Setup

Your PC has a built-in modem and a cable attached to it. You can enjoy the Internet and e-mail services by simply connecting your PC to the telephone line.

- 1. Plug the attached modem cable into the Modem jack of your PC until it clicks. Insert the cable connector into the jack in the correct direction.**

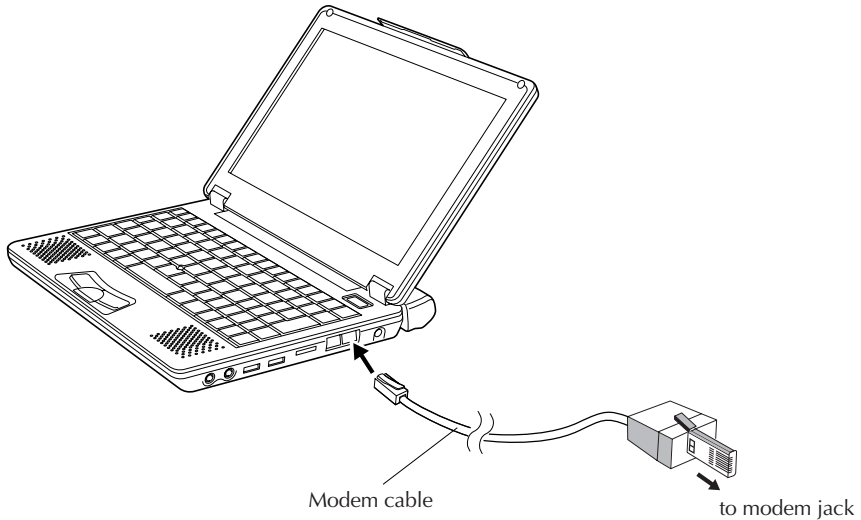

- 2. Plug the other end of the modem cable into the telephone line wall jack.**

If a telephone set is already connected to the telephone line, unplug the cable of the telephone set.

### Tips

Purchase a line splitter if you wish to plug in your telephone set and your PC to the same telephone line. Remember that you cannot use the telephone set and The Internet services simultaneously even if you have installed the line splitter.

### 3. Setting up the modem

- ① Click [start] and [Control Panel] in this order.
- ② Click [Printers and Other Hardware].
- ③ Click [Phone and Modem Options].
- ④ When the "Location Information" screen appears, enter a city code in the "area code" field. Usually, enter your city code here.

Enter the phone company ID number and extension number as necessary. (They are usually not required.)

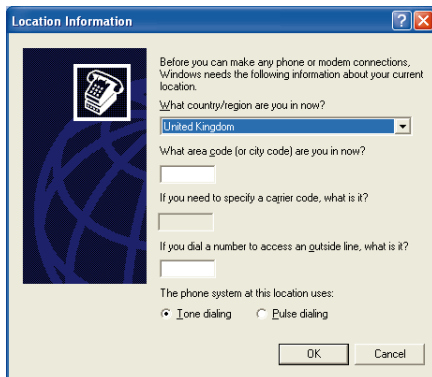

- ⑤ Check the dialing type of your telephone line, and select it correctly.
- ⑥ Click [OK], and the "Location Information" screen will close. Modem setup will be complete.

## The Internet Connection Setup

Use the following procedure to connect your PC to the Internet network. This setup example uses the built-in modem of your PC and Microsoft's Internet Explorer (IE) for the Internet connection. If you have already contracted with a provider, you can manually set up the Internet connection using the following procedure.

### Tips

As your PC has networking functions, you can connect it to the Internet via the network. For the setup procedure, when you connect to the Internet via a network, see Page 63.

### 1. Click [start] and then click [Internet] in the upper left part of the Menu.

The "Welcome to the New Connection Wizard" screen will appear.



### Tips

If the "Welcome to the New Connection Wizard" screen does not appear, click the [start] button and select [All Programs], [Accessories], [Communications] to start [New connection wizard].

### 2. Click [Next].

The "Network Connection Type" screen will appear.

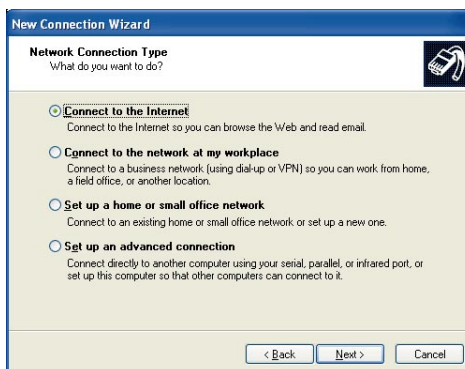

3. Click [Connect to the Internet] option, and click [Next].

The "Getting Ready" screen will appear.

4. Click [Set up my connection manually] option, and click [Next].

The "Internet Connection" screen will appear.

5. Click [Connect using a dial-up modem] option, and click [Next].

The "Connection Name" screen will appear.

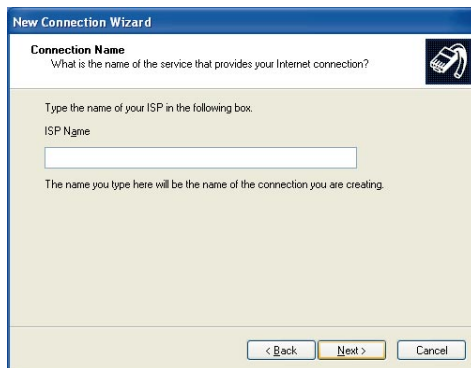

The screenshot shows a Windows-style dialog box titled "New Connection Wizard". The main heading is "Connection Name" with a sub-question "What is the name of the service that provides your Internet connection?". To the right is a small icon of a hand holding a telephone receiver. Below the heading, it says "Type the name of your ISP in the following box." followed by "ISP Name" and a text input field. A note below the field states "The name you type here will be the name of the connection you are creating." At the bottom are three buttons: "< Back", "Next >" (highlighted in yellow), and "Cancel".

6. Enter the "ISP name" and click [Next].

The "Phone Number to Dial" screen may appear.

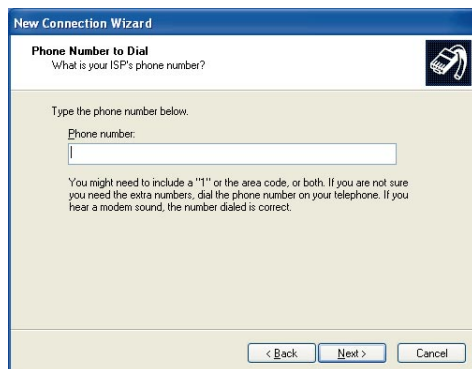

The screenshot shows a Windows-style dialog box titled "New Connection Wizard". The main heading is "Phone Number to Dial" with a sub-question "What is your ISP's phone number?". To the right is a small icon of a hand holding a telephone receiver. Below the heading, it says "Type the phone number below." followed by "Phone number:" and a text input field. A note below the field states "You might need to include a '1' or the area code, or both. If you are not sure you need the extra numbers, dial the phone number on your telephone. If you hear a modem sound, the number dialed is correct." At the bottom are three buttons: "< Back", "Next >" (highlighted in yellow), and "Cancel".

### Tips

It is convenient to use the contracted provider name as the ISP name.

## 7. Enter the phone number, and click [Next].

The "Internet Account Information" screen will appear.

**New Connection Wizard**

**Internet Account Information**  
You will need an account name and password to sign in to your Internet account.

Type an ISP account name and password, then write down this information and store it in a safe place. (If you have forgotten an existing account name or password, contact your ISP.)

User name:

Password:

Confirm password:

Use this account name and password when anyone connects to the Internet from this computer

Make this the default Internet connection

Turn on Internet Connection Firewall for this connection

< Back   Next >   Cancel

## 8. Enter the User name and Password (and enter the password again for confirmation), and click [Next].

The "Completing the New Connection Wizard" screen will appear.

**New Connection Wizard**

**Completing the New Connection Wizard**

You have successfully completed the steps needed to create the following connection:

**Dial-up Connection**

- Make this the default connection
- This connection is firewalled
- Share with all users of this computer
- Use the same user name & password for everyone

The connection will be saved in the Network Connections folder.

Add a shortcut to this connection to my desktop

To create the connection and close this wizard, click Finish.

< Back   Finish   Cancel

## 9. Click [Finish]. The setup for connection wizard is complete.

## Tips

If you need to set up the DNS server address, follow steps 10 to 20.

You may need to set up DNS server addresses (the primary and secondary DNS addresses) for some providers. If the DNS server addresses are stated on the documents sent from your provider, you need to set them up. If not specified, you need not set these addresses.

**10. Click [start] and [Control Panel] in this order.**

The "Pick a category" screen of the Control panel will appear.

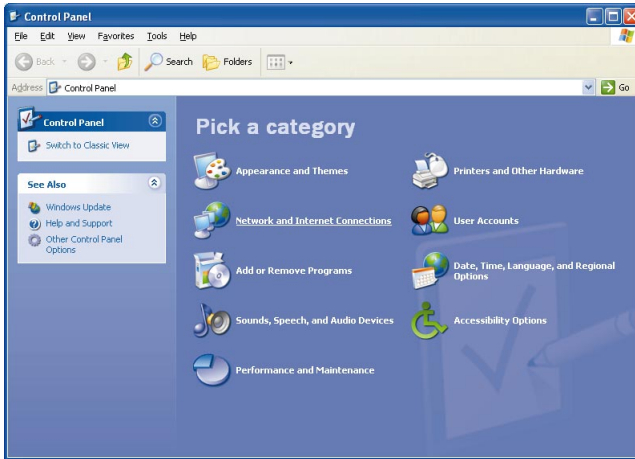

**11. Click [Network and Internet Connection] icon.**

The "or pick a Control Panel icon" screen will appear.

**12. Click [Network Connection].**

The ISP name you have set in Step 6 is shown in the "Dial-up" tag.

**13. Double Click the dialup connection icon.**

[Connect Dial-up Connection] screen will appear.

**14. Click [Properties].**

The "Dial-up Connection Properties" screen will appear.



15. Click [Networking].

16. Click [Internet Protocol (TCP/IP)] and click [Properties].

The "Internet Protocol (TCP/IP) Properties" screen will appear.

17. Click [Obtain an IP address automatically], click [Use the following DNS server addresses], and enter the DNS server address printed on the document sent from the provider.

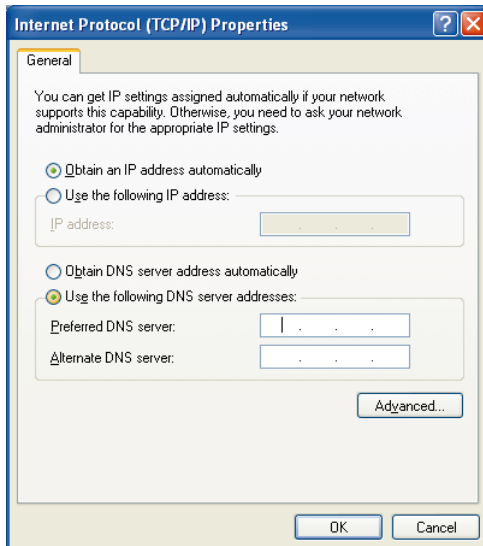

18. After you have entered the addresses, click [OK].

19. Respond with [OK] to the "Dial-up Connection Properties".

20. Click [x] at the upper right corner of the "Network Connection" screen.

All screens will close and the Internet connection is complete.

## Connecting to the Internet

After you have completed the "The Internet Connection Setup" procedure (pages 37 to 41), you can connect to the Internet. Use the following procedure.

### 1. Click [start] and click [Internet] at the upper left part of the Menu.

The Internet Explorer will start up and the "Dial-up Connection" screen will appear. If the "Dial-up Connection" does not start, use the following steps.

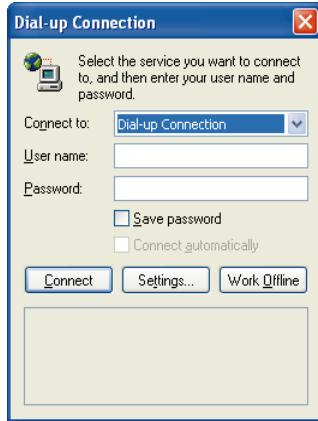

- ① Click [start] and right click [Internet] at the left upper end of the Menu. Then, select [Internet Properties].
- ② Click the [Connections] tab and make sure that the ISP name (you have created in Step 6 "The Internet Connection Setup" on page 38) has been set to default in the [Dial-up and Virtual Private Network settings]. If not set as default, select the ISP and click [Set Default].
- ③ Click [Always dial my default connection], and click [OK].

### 2. Click [Connect].

The dialup connection process will start and your PC will be connected to the Internet.

#### Tips

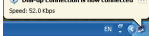
When your PC is connected to the Internet, the icon  appears in the Task tray at the bottom right corner of the desktop screen.

## Disconnection from the Internet

When you are connected to the Internet, the use of the telephone line and the access to the provider are charged.

Disconnect your PC from the Internet in one of the following ways when you are finished using the Internet.

- Double-click the task tray connection icon  at the bottom right corner of the desktop screen. When the "Auto Disconnect" dialog box appears, click [Disconnect Now].
- Quit the Microsoft's Internet Explorer (IE). When the "Auto Disconnect" dialog box appears, click [Disconnect Now].

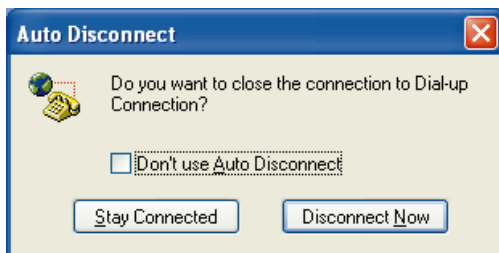

## Accessing a Web Page

There is a large number of Web sites available. You can access a Web site using Microsoft's Internet Explorer in your PC. The following shows three typical ways you can use to access a Web site.

Before starting the following steps, connect your PC to the Internet using the "Connecting to the Internet" procedure on Page 42.

When Microsoft's Internet Explorer is active, you can access a Web site in one of the following ways.

1. Directly enter the URL in the address bar.
2. Jump to the destination link.
3. Click [Favorites] and select Call a Web site from the Favorites.

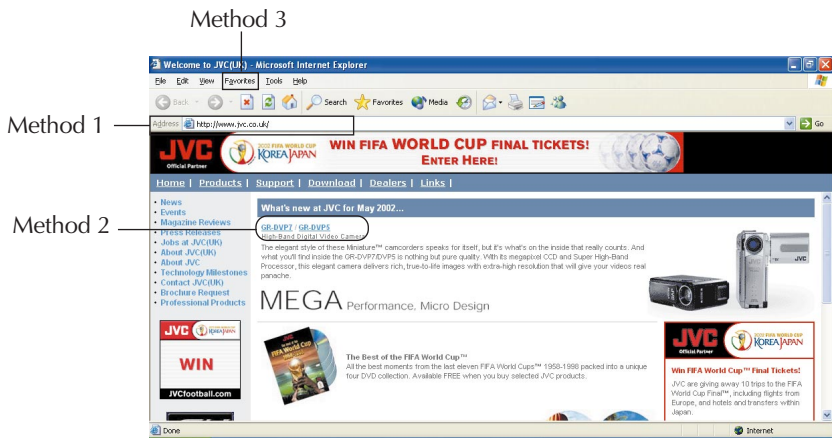

# E-MAILING

You need to set up a mailing software to send and receive E-mails.

## Setting up E-Mail Software

Set up the E-mail transmission using the Outlook Express installed on your PC.

### Tips

It is convenient for E-mail setup if you have the document sent from the provider to hand.

#### 1. Click [start] and click [E-mail] on the Menu.

Outlook Express will start and the "Internet Connection Wizard" screen will appear.

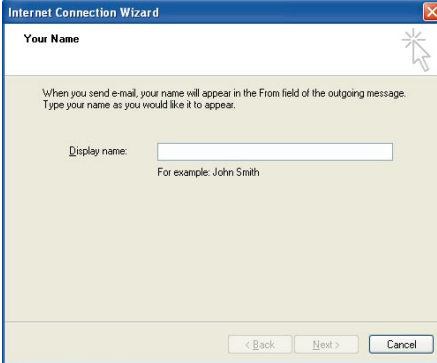

The screenshot shows the 'Internet Connection Wizard' dialog box with the title bar 'Internet Connection Wizard'. The main heading is 'Your Name'. Below the heading, there is a text box for 'Display name:'. The text inside the text box is empty. Below the text box, it says 'For example: John Smith'. At the bottom of the dialog box, there are three buttons: '< Back', 'Next >', and 'Cancel'. A mouse cursor is pointing at the top right corner of the dialog box.

#### 2. Enter the name you wish to display in the "Display name" and click [Next].

The "Internet E-mail Address" screen will appear.

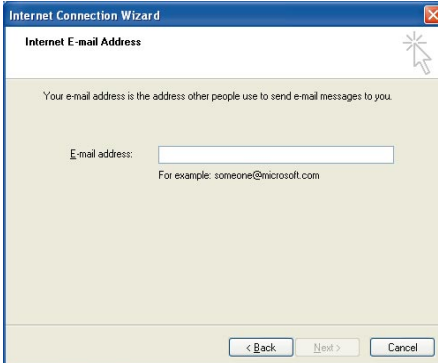

The screenshot shows the 'Internet Connection Wizard' dialog box with the title bar 'Internet Connection Wizard'. The main heading is 'Internet E-mail Address'. Below the heading, there is a text box for 'E-mail address:'. The text inside the text box is empty. Below the text box, it says 'For example: someone@microsoft.com'. At the bottom of the dialog box, there are three buttons: '< Back', 'Next >', and 'Cancel'. A mouse cursor is pointing at the top right corner of the dialog box.

**3. Enter your E-mail address in the "E-mail address" field, and click [Next].**

The "E-mail Server Name" screen will appear.

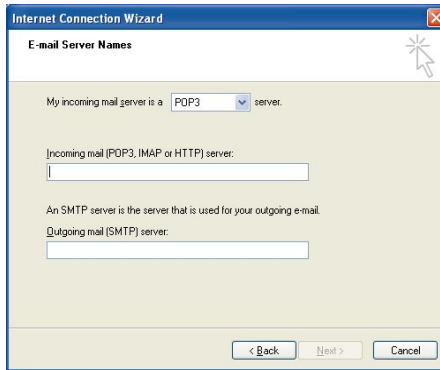

The screenshot shows the "Internet Connection Wizard" window with the "E-mail Server Names" tab selected. The window has a blue title bar and a close button in the top right corner. The main area is light beige and contains the following text and controls:

- "My incoming mail server is a  server." (The dropdown menu is currently set to "POP3")
- "Incoming mail (POP3, IMAP or HTTP) server:" followed by an empty text input field.
- "An SMTP server is the server that is used for your outgoing e-mail."
- "Outgoing mail (SMTP) server:" followed by an empty text input field.
- At the bottom, there are three buttons: "< Back", "Next >", and "Cancel".

**4. Enter the "Incoming mail server" and "Outgoing mail server", and click [Next]. Usually select "POP3" as the "My incoming mail server is a  server." but you can change it if necessary.**

The "Internet Mail Logon" screen will appear.

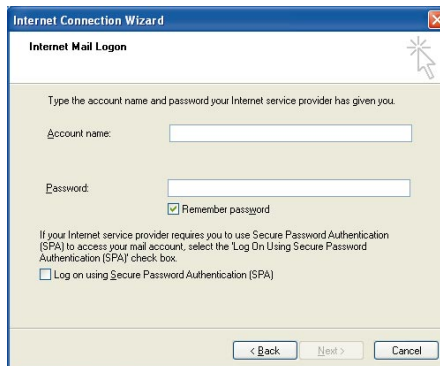

The screenshot shows the "Internet Connection Wizard" window with the "Internet Mail Logon" tab selected. The window has a blue title bar and a close button in the top right corner. The main area is light beige and contains the following text and controls:

- "Type the account name and password your Internet service provider has given you."
- "Account name:" followed by an empty text input field.
- "Password:" followed by an empty text input field.
- A checked checkbox labeled "Remember password".
- Below that, a paragraph of text: "If your Internet service provider requires you to use Secure Password Authentication (SPA) to access your mail account, select the 'Log On Using Secure Password Authentication (SPA)' check box."
- A checkbox labeled "Log on using Secure Password Authentication (SPA)".
- At the bottom, there are three buttons: "< Back", "Next >", and "Cancel".

**5. Enter the "Account name" and "Password," and click [Next].**

The "Congratulations" screen will appear.

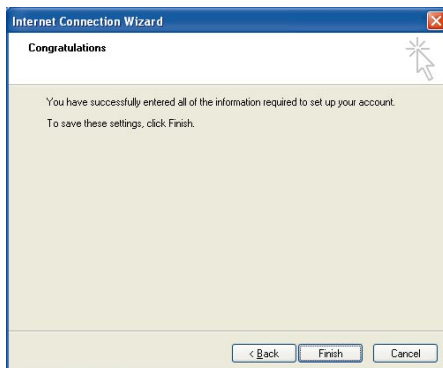

**6. Click [Finish].**

The "Congratulations" screen will close, and Outlook Express will start up.  
The setup for the E-mail software is complete.

**7. To quit Outlook Express, click [x] at the upper right corner of the screen.**

## Sending and Receiving E-mails

You can create and send E-mail messages, and receive and read E-mail from others. You can learn procedures to enjoy E-mailing. Use Outlook Express installed on your PC for E-mail transmission.

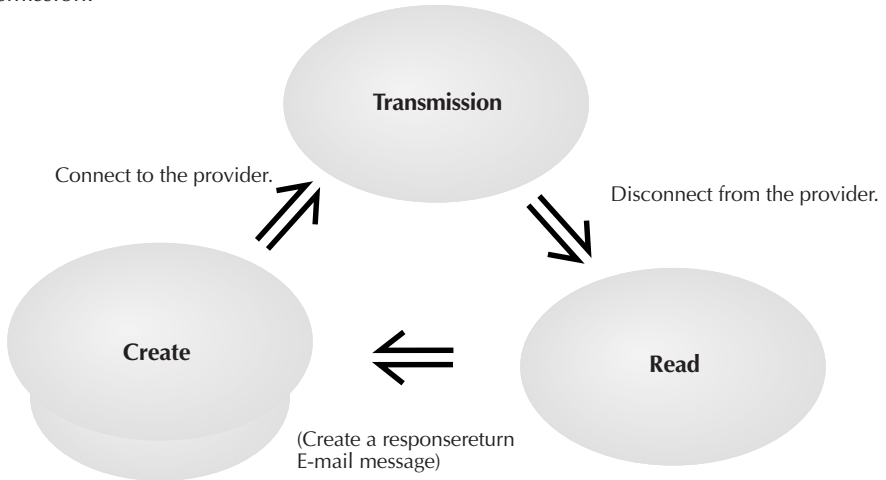

### 1. Click [start] and click [E-mail] on the Menu.

Outlook Express will start.

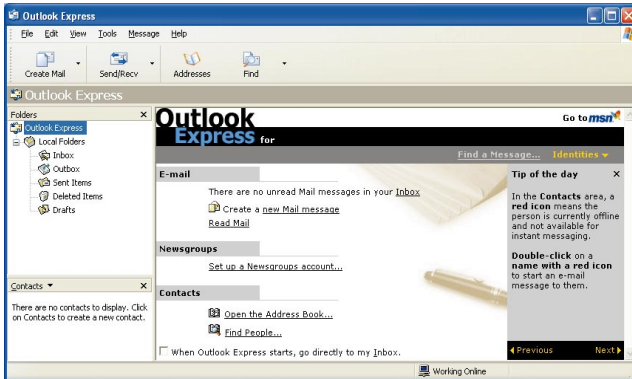

### 2. Click [Create a new Mail message] on the screen and click [Create Mail] in the toolbar.

The "New Message" screen will appear.

#### Tips

To minimize the access fee to the provider and the use of the telephone line, create your E-mail messages before connecting to the Internet.



### 3. Create a message.

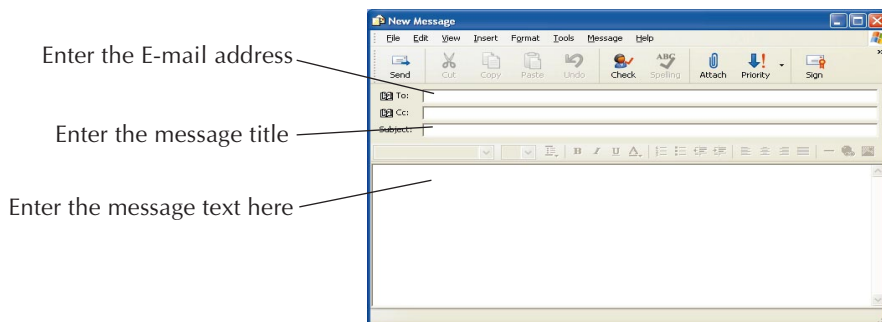

**Destination:** Enter the receiver's E-mail address. (Enter your E-mail address first to test E-mail transmission.)

**Title:** Enter the message title.

### 4. Click [Send] at the left upper end of the screen to send the created message.

The "Dial-up Connection" screen will appear.

#### Tips

If you have already connected to the Internet, the "Dial-up Connection" screen is not displayed but the message is directly sent when you click [Send].

### 5. Click [Connect] in the "Dial-up Connection" screen to connect to the Internet.

You will be connected to the Internet, and the created mail will be sent to the specified address.

### 6. If your mail transmission is successful, try to receive E-mail. When you are connected to the Internet, click [Send/Recv] at the left upper end of the screen.

Your PC will be connected to the provider's mail server and you can receive E-mail. Assuming you have set your E-mail address correctly in Step 3, you can now receive the test E-mail you have sent to yourself.

#### Tips

If message "You are currently working offline. Would you like to go online now?" appears when you have clicked [Send] or [Send/Recv], respond with [Yes].

7. To check the received messages, click [Inbox] on the screen.

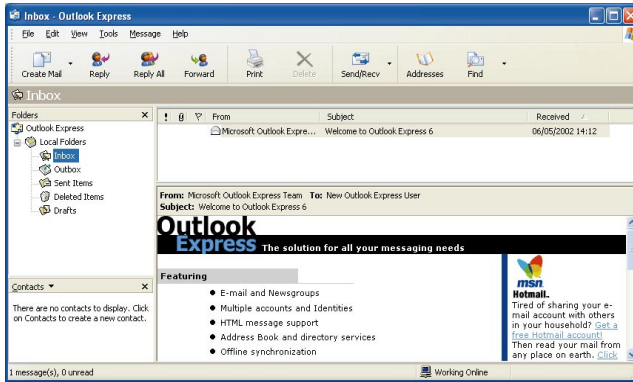

The received E-mail messages will be displayed.

8. To quit Outlook Express, click [x] at the upper right corner of the screen.

### Caution

- Disconnect your PC from the Internet after you have transmitted E-mail and finished accessing a Web site.
- It may not be possible to send mail properly using a company network or roaming service. If this problem arises, the method below may solve it.  
**Before sending the mail, first perform the receive mail operation even if no mail has been received, and then click [Send].**

# 4

## HARDWARE

## Using the Pointing Device

The pointing devices allow you to move the mouse pointer on the screen. You can move the cursor using the centre stick and three buttons in the similar way as the mouse.

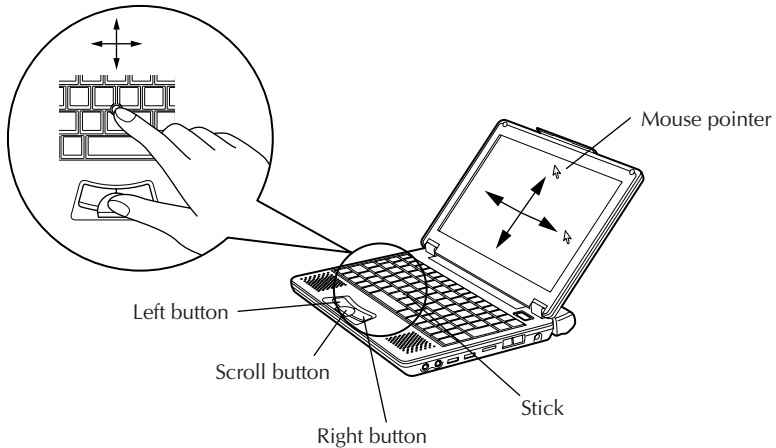

### • Stick operations

Usually operate the stick using your index finger. The mouse pointer moves in the direction you press the stick. You can adjust the pointer moving speed by controlling the power to press. You can control the speed of mouse pointer movement by changing the pressure to the stick.

When you press the stick harder, the mouse pointer moves more quickly.

### Notes

- If you press the stick slightly and move the pointer slowly for several seconds, the pointer may return backward. This is not a fault.
  - Two stick caps are included in the PC accessory pack. When the cap has deteriorated, replace it with a new one.
- ### • How to press the buttons

Usually press the three buttons using your thumb.

#### • Click

Press the mouse left button once and release it immediately.

Use this operation to select a menu option or to press the [OK] or [Cancel] button.

#### • Right click

Press the mouse right button once.

Use this operation to display a popup menu (called the shortcut).

- **Double-click**

Press the mouse left button twice in succession and release it immediately.

- **Drag**

Use this operation to move an icon or a file. To do so, select an icon or a file, hold down the mouse left button and move it to the desired position, and release the mouse button.

**Notes**

The pointing devices have initially been set for the "right-handed person" on the "Mouse properties" tab.

- **Scroll buttons**

You can scroll the screen in the desired direction by holding down the scroll button and moving the stick horizontally or vertically.

**Notes**

Some applications may not support the scroll buttons.

## Using Hot keys

You can use the coloured hot keys of the PC keyboard. Hold down the **Fn** key and press one of the Hot keys to execute its command.

### List of hot keys

- F1** Reduces the screen brightness level. Use this command to reduce the brightness level if the screen is too bright.
- F2** Increases the screen brightness level. Use this command to increase the brightness level if the screen is too dark.
- F3** Stand by the Mobile PC.
- F4** Hibernate the Mobile PC.
- F5** Reduces the volume.
- F6** Increases the volume.
- F7** Turns the PC speaker on or off.
- F9** Sets the wireless LAN to ON or OFF (XP-7230GB only).  
(Refer to "Network connections using a wireless LAN" on pages 67 and 68.)
- F10** Switches between the LCD display and an external monitor. (Mode switching from LCD panel to LCD plus CRT display, to CRT display)
- F11** Turns the Num Lock key on or off. For operation details, see "Using the Numeric Keypad" of the next section.
- F12** Turns the Scroll Lock key on or off.
- Ins** Issues the Print Screen (PrtSc) command. The screens displayed in the Windows are copied onto the clipboard. You can select a window and copy it using the **Alt** key together.

### Note

- The hot keys are not supported in the MS-DOS environment.
- If a key top has come off, refer to page 55.

## Using the Numeric Keypad

Sixteen keys of the keyboard have been assigned to the numeric keypad. Each of these keys has two labels in different colours to identify their functions. (Blue characters printed on the diagonal part of the key are numeric keypad keys.)

### To use the numeric keypad:

Hold down the **Fn** key and press the **NumLK** key. When the numeric keypad is functional, the Num Lock lamp lights. (See the "Status Indicators" on Page 19. Now, you can enter a numeral printed in blue on the diagonal part of the key.

## If a key top has come off

If a key top has come off from the keyboard, put it back in place by following the procedure below.

### • How to attach the Enter key, left Shift key or Space key top

- ① Take out the disengaged wire rod, and snag it onto the two projections as shown in the figure below.
- ② Place the disengaged rubber cushion at the position shown in the figure below.
- ③ Align the center position of the key top with the center position of the rubber cushion, and press the key top down until it clicks into place.
- ④ Operate the key with its key top now in place as you would operate it normally, and check that it does not come off.

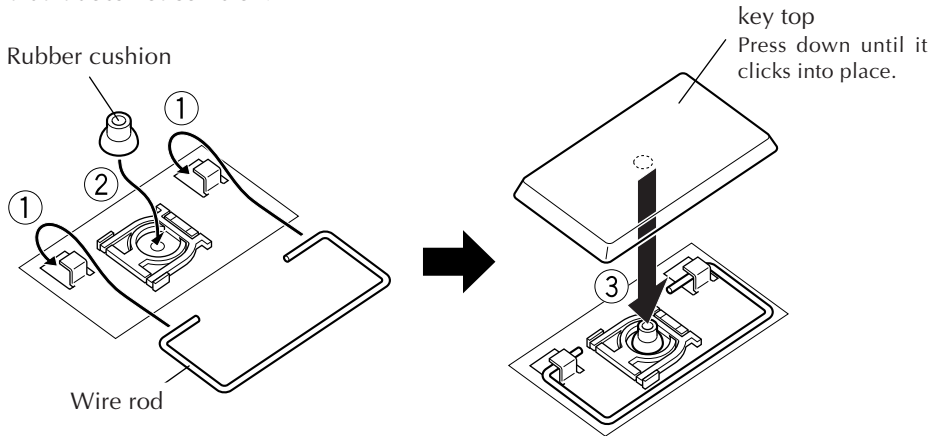

### • How to attach any other key top

The wire rod shown above is provided with Enter key, left Shift key and Space key only. When the key top of any other key has come off, follow steps ② to ④ above.

### Note

- As soon as the key top clicks into place in step ③ of the procedure to attach the key top, do not apply any further pressure to it or the key may be damaged.

## Increasing the (Optional) Memory Capacity

You can increase the PC memory capacity up to 384M bytes. For the built-in memory capacity, see the Product Specifications on Page 102. You can reduce the application startup time and increase the data process speed by adding an optional memory board.

Consult the JVC PC Technical Support Centre listed at the end of this manual for memory expansion.

### Notes

- Check the memories supported by your PC by accessing:  
**<http://www.jvc.co.uk>**  
The memory boards which have been checked for reliable operations are listed on our Web site. Any other memory board may not be recognized by your PC or its operation may be unreliable.
- The PC inside contains precision components. If you have damaged the memory board by adding a memory, it is not covered by the warranty. Also, if you have damaged your PC, you will be charged for its repair.
- Take care not to cause excessive static electricity. Do not add a memory board in a place where static electricity may be generated.
- When you add or replace a memory board, take care not to drop water or other liquids onto your PC or the memory board. Also, take care not to drop screws or other foreign materials that may cause the failure of your PC.
- Data stored in the PC may be corrupted or damaged in the following cases.
  - The battery is used incorrectly.
  - The PC is affected by static electricity or electrical noise.
  - The battery has discharged.
  - The PC is faulty or under repair.
  - The PC is dropped or exposed to severe impact.
  - The PC is involved in force majeure including lightning or power failure.



## Adding or Removing a Memory Board

If you have operated your PC, its inside may be hot and you may get a burn. Turn the power switch off and wait for the PC to cool down.

1. **Turn the PC Power switch off, and disconnect AC adapter from your PC. Then, remove the standard lithium ion battery pack (if any) and all other peripherals from your PC.**
2. **Remove the built-in lithium ion battery pack and the memory expansion cover by taking the following steps.**
  - 1) Turn your PC upside down, and remove screws ① to ④.
  - 2) Remove the built-in lithium ion battery pack.
  - 3) Open the memory expansion cover.

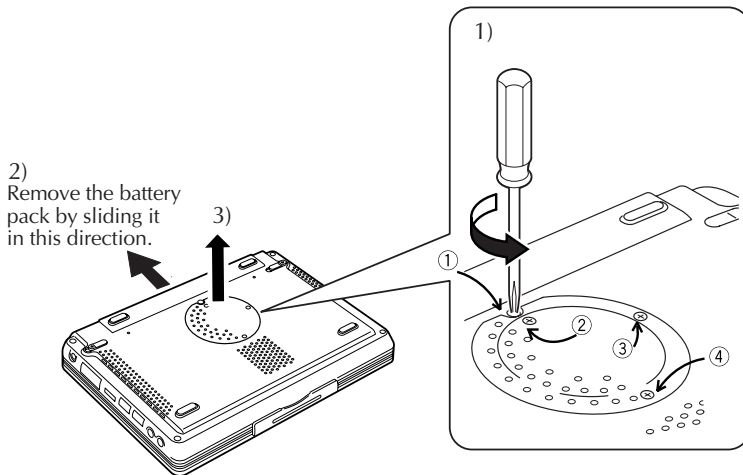

### Cautions

- Screw ① (10 mm) is different in length from screws ② to ④ (3 mm). Using a wrong screw can damage your PC.
- Do not loosen any other screws, otherwise, your PC may fail.

3. **Discharge any static electricity from your body by touching something metallic nearby.(Not on the PC)**
4. **Add or remove a memory board.**

### Cautions

The MP-XP7230GB PC already has 128M-byte memory in its memory slot. You need to replace it with a 256M-byte memory board to expand the PC memory capacity to the maximum 384M bytes. To do so, remove the 128M-byte memory board from the slot. See Procedure "2) Remove the memory board" on Page 58.

### 1) Mounting a memory board

- ① Check the correct mounting direction of memory board (by observing the cut area).
- ② Slant the memory board and insert it into its socket.
- ③ Push the memory board until it is locked, but do not apply excessive force to it.

#### Cautions

If it is difficult to lock the memory board, make sure that the board has been inserted securely. Do not apply excessive force to it, or the memory board may be damaged.

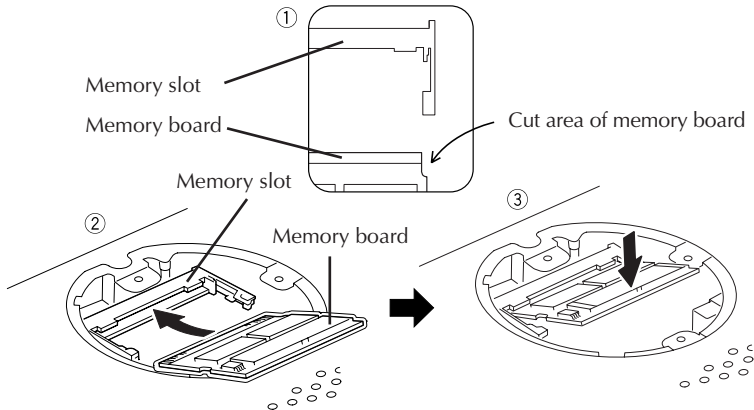

### 2) Removing the memory board

- ① Open the right and left support levers of the memory board by pressing them outward.
- ② Pull out the memory board in the arrow direction.

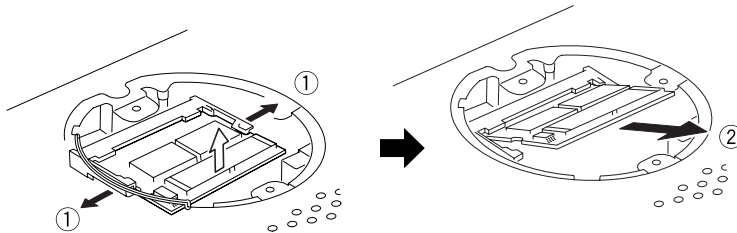

### 5. Return the memory expansion cover, mount the battery pack, and retighten the four screws.

#### Caution

The screws have different lengths. Be careful to use the right screw in the right place.

## Checking the Additional Memory Board

Use the following procedure to check the memory board installation.

1. Turn on your PC and start Windows.
2. Click [start] and select [Control Panel].
3. Click the [Performance and Maintenance] icon.
4. Click the [System] icon.

The "System Properties" screen will appear.



5. The total amount of memory appears on the screen.

- 368 MB RAM appears when 384 MB (128 MB + 256 MB) of memory is installed.
- 240 MB RAM appears when 256 MB (128 MB + 128 MB) of memory is installed.

### Note

The size of the video memory (assigned size) was set to 16MB prior to shipment from the factory.

## Using the SD Memory Card Slot

Your PC has an SD memory card slot.

An SD memory card or multimedia card can be used.

When you use an SD memory card, remove the dummy card from the SD memory card slot.

### 1. Remove the dummy card.

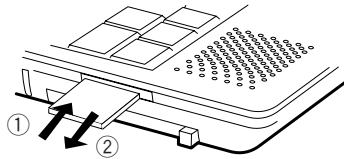

- ① Press the dummy card slightly, and it will be ejected.
- ② Hold the ejected card and remove it from your PC.

### 2. Insert an SD memory card.

Caution: Insert the SD card in the correct direction.

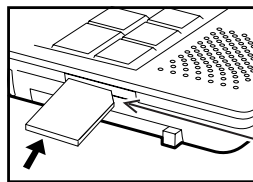

Check the cut area.  
(The terminal side  
must face downward.)

#### Notes

- The SD memory card and multimedia card are optional.
- The SD memory card slot of your PC does not support the SD I/O function and data transfer using the copyright protection functions.
- If you do not use an SD memory card on your PC, keep the dummy card inserted in the slot to prevent dust or other foreign bodies getting into the PC.
- When formatting an SD memory card or MultiMedia card in this PC's SD memory card slot for use in a DVC or digital camera, first select [FAT] rather than [FAT32] on the Windows XP format screen, and then proceed with the formatting.
  - \* Before formatting a memory card, back up its contents on the PC's hard disk drive, for instance.

## Using an External Monitor

To attach an external monitor to your PC, use the MP-VGX1E external display cable.

### Connecting an external monitor

When you connect an external monitor to your PC, it looks like an ordinary desktop PC. You can use the monitor by just connecting it with the MP-VGX1E cable. You can display images on the external monitor for other people and you can watch them on the LCD panel of your PC.

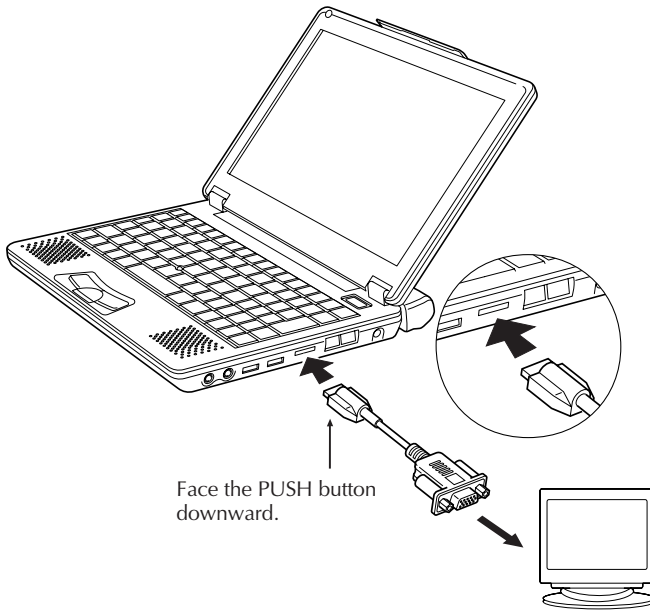

For display switching between the external monitor and the LCD panel of your PC, see "Using the hot keys" on Page 54.

### Note

- To disconnect the external display connecting cable (MP-VGX1E), be absolutely sure to pull it straight out while pressing the PUSH button at the same time.

- The display max resolution you can set for the external monitor is 1600 x 1200 x 32 bits, which depends on monitor performance.
- When the display resolution is set to 1024 x 600 x 32-bit colours, enabling the simultaneous display of internal and external monitors automatically changes the number of display colours to 16-bit colour display. If you then select the separate display of internal and external monitors, the number of colours is not automatically changed. Thus, to enable the 32-bit colour display, you must re-define the number of colours with the Display Properties dialog box.
- Caution when the expansion display with a resolution of 800 x 600 is disabled. (shipment setting: enabled)

Since the mirror mode (screens displayed by the LCD and external display unit) is set after startup when the power is turned on with the PC connected to the external display, use the hot key ( **[Fn]** + **[F10]**: see page 54) to select the display again in line with the mode that will be used.

- \* How to enable and disable the expansion display with an LCD resolution of 800 x 600
  - 1) Press the **[Alt]** + **[F2]** keys when the system starts up (when the JVC logo is displayed).
  - 2) The "Award BIOS Setup Utility" screen will appear. Select [Advanced] using the **[→]** cursor key.
  - 3) Select "LCD Expansion" using the **[↓]** cursor key and press **[Enter]**. Then select [Enabled] or [Disabled] using the **[↓]** cursor key, and press **[Enter]**.
  - 4) Next, press the **[F10]** key. "Setup confirmation" will appear so select [Yes], and press **[Enter]**.

**(If you are not thoroughly familiar with PCs, do not change the BIOS settings. Selecting the wrong settings may not only make it impossible for the PC to start up but it may even cause malfunctioning.)**

## Connecting to a network

With the network function, you can connect to a network at your office or home to transfer data between PCs and access the Internet from multiple PCs. For setting for intranet connection, consult a system administrator at your company. Connection to a network requires the following items.

- LAN cable
- Communication devices including a hub or router

### Important

LAN cables are available in straight and cross types. Use a cable of the correct type for your LAN environment.

You must contract with an Internet service provider.

Using a LAN cable, connect the LAN connector on the unit with a communication device (hub or router).

See the following for setting.

## Setting for network connection

### ● Setting the IP address manually

#### Important

This PC will acquire the necessary initial settings automatically. When you use this PC in a home network environment and the IP address is assigned automatically, the following steps are not necessary.

- ① Click the [start] button and [Control Panel].
- ② Click the [Network and Internet Connections] icon.
- ③ Click the [Network Connections] icon.

The “Network Connections” screen will appear.

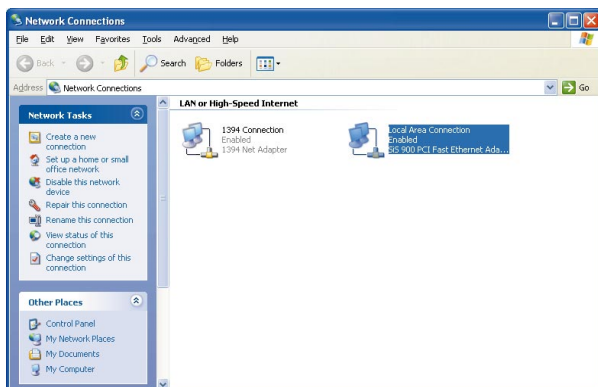

- ④ Double-click [Local Area Connection].  
The “Local Area Connection Status” screen will appear.

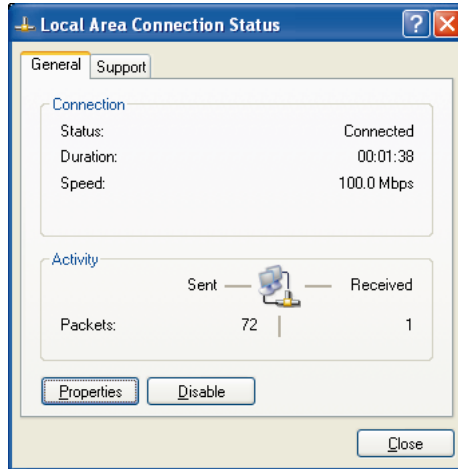

- ⑤ Click the [Properties] button.  
The “Local Area Connection Properties” screen will appear.
- ⑥ On the [General] tab, double-click [Internet Protocol (TCP/IP)].  
The “Properties of Internet Protocol (TCP/IP)” screen will appear.
- ⑦ Enter appropriate values in the [Use the following IP address] and [Use the following DNS server addresses] fields.
- ⑧ Click the [OK] button to save the setting.

## ● Setting a computer name or work group

### Tips

To share data or a printer among a group of computers, you must set the computers in the same work group. This enables you to transfer data between computers.

- ① Click the [start] button and [Control Panel].
- ② Click the [Performance and Maintenance] icon.
- ③ Click the [System] icon.  
The “System Properties” screen will appear.
- ④ Click the [Computer Name] tab.
- ⑤ Click the [Change] button.
- ⑥ Change the “Computer name” and/or “workgroup” as necessary.
- ⑦ Click the [OK] button to save the setting.  
The “Change in computer name” screen containing the “Welcome to the \*\*\* workgroup.” message will appear.



- ⑧ Click the [OK] button.  
A message prompting you to restart the computer will appear.
- ⑨ Click the [OK] button to make the change take effect.
- ⑩ Restart the computer.

## ● Checking the MAC address

Use the following procedure to check the MAC address of the internal LAN card.

### Important

To check the MAC address, you have to set a LAN (local area) connection in the [Network connection] screen.

- ① Click the [start] button and [Control Panel].
- ② Click the [Network and Internet Connections] icon.
- ③ Click the [Network Connections] icon.

With the correct LAN connection, the following screen will appear.

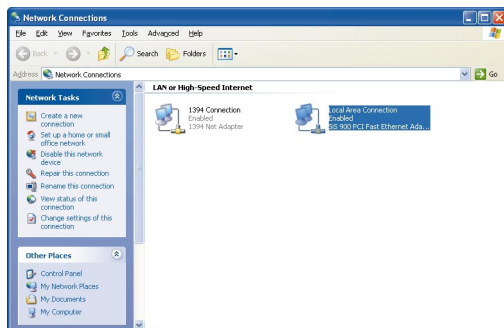

- ④ Check that [Local Area Connection] is enabled.

### Tips

if it is disabled, move the mouse pointer to [Local Area Connection] and press the right mouse button to bring up a menu, click [Enable] to enable the connection.

- ⑤ Double-click [Local Area Connection].  
The “Local Area Connection Status” screen will appear.

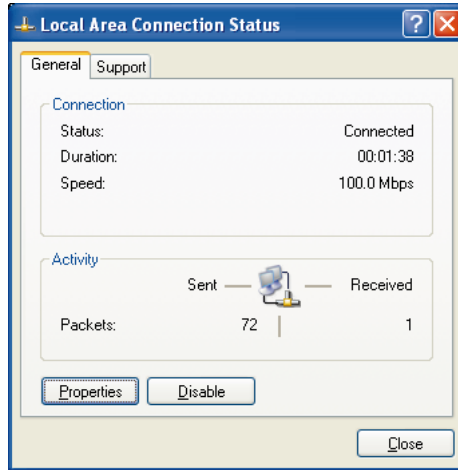

- ⑥ Click the [Support] tab and the [Details] button.  
The “Network Connection Details” screen will appear.
- ⑦ The MAC address is displayed as the “Physical Address” on the list.

## Network connections using a wireless LAN (MP-XP7230GB only)

The model MP-XP7230GB PC comes with wireless LAN functions. (The MP-XP5230GB series does not come with these functions, and the details provided in “Network connections using a wireless LAN” do not apply.)

You can connect to a LAN system from any location within the wireless communication area to access the Internal LAN or send and receive mail. By using a wireless LAN access point (available from a retail store) which is connected to an ADSL modem (available from a retail store), you can access broadband environments from a multiple number of PCs. Furthermore, you can bring your PC to one of the public wireless LAN services which have been increasing of late and enjoy accessing the Internet by wireless means.

For the wireless network settings and details, refer to [Help and Support] on the [Start] menu.

### General description of wireless LAN

The wireless LAN in this PC supports the following functions.

- Automatic communication speed selection function: 11, 5.5, 2 and 1 (Mbps)
- Frequency channel selection : All 13 channels (2412 to 2472 MHz)
- Roaming between multi-channels
- Power management function
- Compliance with IEEE802.11 and IEEE802.11b standards

### Types of wireless LAN networks

- AdHoc Mode  
In this mode, the data is transferred directly between PCs. It is suited to wireless networks in which data is transferred between several laptops. The peer-to-peer workgroup setting for providing equal handling for all the laptops is established.
- Infrastructure Mode  
In this mode, the PCs are connected through an access point. If the access point is connected to an ADSL, CATV, ISDN or other such line, the PCs can be connected to the Internet as well.

## Suggestions for using the wireless LAN

- Use the wireless LAN in a location where there are as few obstacles as possible. To maximize the distance over which communication with the wireless LAN is possible, open the display, and point its reverse side (the side with JVC logo) at the access point. Do not place any obstacles such as books or thick stacks of paper between the PC and access point.

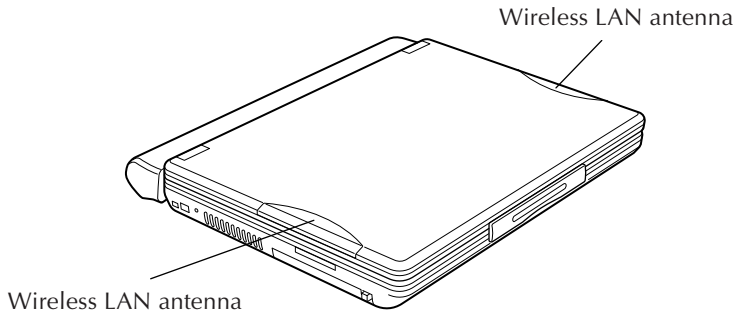

## Setup procedure for the wireless LAN

### Caution

In order to make it easier to check the operation of the PC's wireless LAN, start the access point before proceeding to use the wireless LAN in the infrastructure mode. For use in the AdHoc mode, start the PC that serves as the other end of the communication where the wireless LAN settings have already been completed if possible before proceeding to use the wireless LAN in this mode.

## 1 Start up the PC.

## 2 Set the IP address to be used by the wireless LAN.

- ① Click [Start], and select [Show all connections] from [Connect To] on the start menu.



- ② Select [Wireless Network Connection] on the [Network Connections] screen, and select [Properties] on the [File menu].

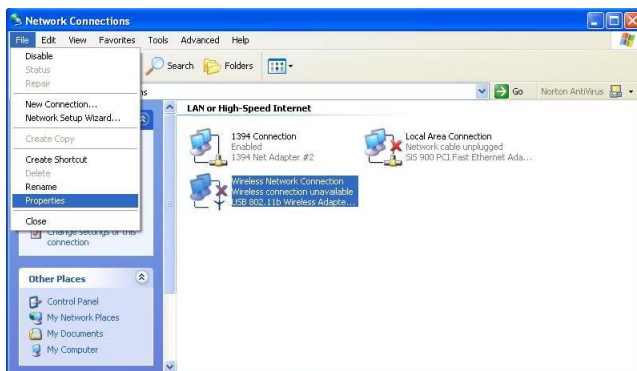

- ③ Select [Internet Protocol (TCP/IP)] on the [General] screen of [Wireless Network Connection Properties].

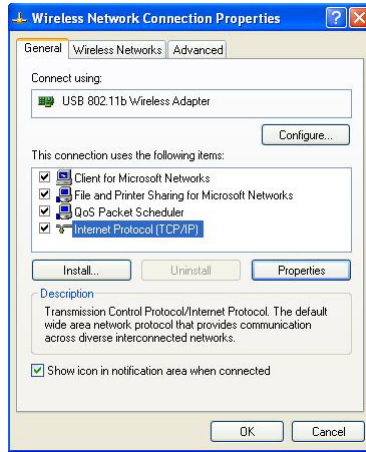

- ④ The [Internet Protocol (TCP/IP) Properties] screen appears.

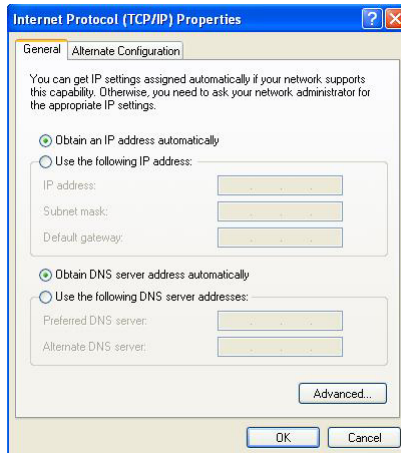

- ⑤ Use the following example as a reference, and proceed with the settings depending on how the wireless LAN is to be used.

**For making the wireless network connection using a public wireless LAN service :**

With a public wireless LAN service, it is customary for the DHCP server function that automatically allocates the IP address to be enabled. On the “Internet Protocol (TCP/IP) Properties” screen, click and select “Obtain an IP address automatically” and “Obtain DNS server automatically” , and click the [OK] button.

**For directly communicating with another PC using a peer-to-peer connection :**

Set the IP address which has the same network address as the IP address of the PC that serves as the other end of the communication. If, for example, the IP address at the other end is 192.168.1.1, click and select “Use the following IP address” on the “Internet Protocol (TCP/IP)” screen, and input 192.168.1.2, for instance, in the “IP address” field. Input 255.255.255.0 for “Subnet mask,” and click the [OK] button.

**For making the wireless network connection via an access point**

In cases involving an in-company LAN, etc. where a DHCP server is in operation on the wired network to which the access point is connected, click and select “Obtain an IP address automatically” and “Obtain DNS server automatically” on the “Internet Protocol (TCP/IP) Properties” screen, and click the [OK] button. (Check with a network administrator to ascertain whether the DHCP server is in operation.)

In a home or other such environment where a DHCP server is not in operation, manually set the IP address to the one that has the same network address as the IP address of the access point. If, for example, the IP address of the access point has been set to 192.168.10.1, click and select “Use the following IP address” on the PC’s “Internet Protocol (TCP/IP)” screen, and input 192.168.10.2, for instance, in the “IP address” field. Input 255.255.255.0 for “Subnet mask,” and click the [OK] button.

When connecting to the Internet using a wireless LAN access point connected to an ADSL modem (available from a retail store), check the method used to set the IP address with the Internet service provider.

**3 Press the **[Fn]** and **[F9]** keys at the same time to turn on the wireless LAN.**

The wireless LAN starts, and the wireless LAN start icon appears at the top left of the display.



The wireless LAN indicator  above the **[F10]** key flashes while a search is being conducted, and it stops flashing and remains lighted once the connection is made.

**Note**

At the time of shipment, the wireless LAN is set to ON. The previous settings will apply when the PC is started up or when its operation is resumed from the standby or hibernation mode. In order to prevent other electronic devices in places such as aircraft and hospitals from being adversely affected, set the wireless LAN to OFF and close down its functions using the hot keys (pressing the **[Fn]** and **[F9]** keys at the same time) if it is possible for the PC to be used in places like these.

When the wireless LAN status icon is clicked on the task tray, the main menu of the wireless LAN setting utility is opened, enabling the wireless LAN status to be checked or set.



The color of the wireless LAN status icon indicates the connection status and signal strength status.

- Green on a white ground: Now connected (signal strength: strong)
- Yellow on a white ground: Now connected (signal strength: weak)
- Red on a white ground: Now searching the base station
- Red cross on a white ground: Wireless LAN in the OFF status
- Red cross on a green ground: Now connected (an error has occurred); the wireless network cannot be used. Re-check the encryption (page 74).

## 4 Perform the wireless network settings.

### ① Status

Wireless LAN connection status display and wireless LAN ON/OFF switch

The connection status, current transmission rate (Mbps) communication channel, throughput (bps), link quality and signal strength are displayed.

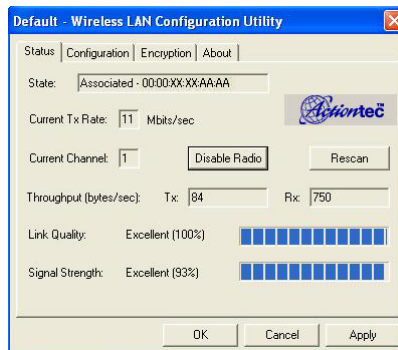

When [Rescan] is clicked, the connection destination is searched again.

When [Disable Radio] is clicked while connected, the wireless LAN function is set to OFF.

When [Disable Radio] is clicked while the wireless LAN is OFF, the wireless LAN function is set to ON, the connection destination is searched, and the connection is established.

The wireless LAN can also be set to ON or OFF by pressing the hot keys ([Fn] + [F9]).

### Note

In the case of a peer-to-peer network type, the link quality and signal strength are not displayed.



## ② Settings

Perform the wireless LAN communication settings.

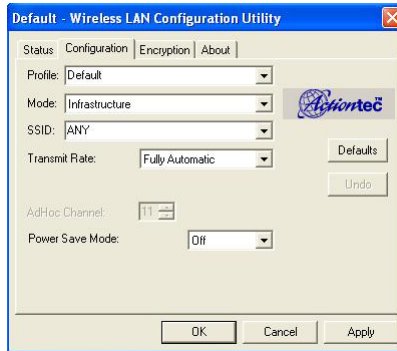

This utility can retain multiple sets of setting information, and these sets can be selected for use. The settings are each managed by a [Profile]. When new settings are to be added, input the profile name of your choice, and then proceed with the settings.

**[SSID]**

Perform the ESS-ID setting for the network name. The wireless LAN group can be created by setting the ESS-ID. When it has been set, communication is possible only with the connection destination for which the same ID has been set.

**[Mode]**

Select either access point (infrastructure mode) or peer-to-peer (AdHoc mode) as the network type to be used.

For details on each of these network types, refer to the unit's instruction manual (page 78).

**Notes**

When constructing a peer-to-peer network, select the channel number to be used using [AdHoc Channel].

**[Power Save Mode]**

Select On, Off or Auto as the power-saving mode setting.

**[Transmit Rate]**

1Mb: The transmission rate is fixed at 1 Mbps.

2Mb: The transmission rate is fixed at 2 Mbps.

Auto 1 or 2Mb: The transmission rate is automatically selected from 1 Mbps or 2 Mbps.

5.5Mb: The transmission rate is fixed at 5.5 Mbps.

11Mb: The transmission rate is fixed at 11 Mbps.

All auto: The transmission rate is automatically selected.

When [OK] or [Apply] is clicked, the settings are saved or changed.

## ③ Encryption

Perform the encryption (WEP security) settings for communication.

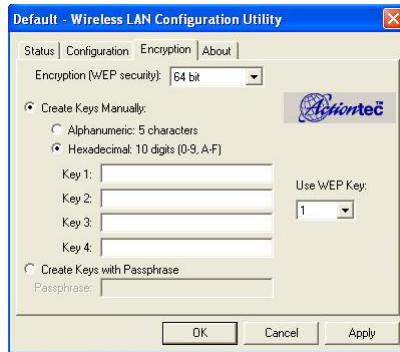

The WEP function encrypts key words and scrambles them in the transmission data. A network using a high level of security can be configured when it is activated. While the function is activated, the same WEP keys must be used by all the computers in the group. Set the WEP keys by following the steps below.

#### [Encryption (WEP security)]

As the WEP function setting, select “64 bit,” “128 bit” or “Not Used.”

As the WEP key input method, select [Create Keys Manually] or [Create Keys with Passphrase].

#### [Create Keys Manually]

- Alphanumerics: 5 or 13 characters

Select this setting to designate the WEP keys using specific alphanumerics.

Set 5-character keys with the 64-bit WEP function setting and 13-character keys with the 128-bit WEP function setting.

- Hexadecimal: 10 or 26 characters

Select this setting to designate the WEP keys using hexadecimal notation (0-9, A-F).

Set 10-character keys with the 64-bit WEP function setting and 26-character keys with the 128-bit WEP function setting.

- Key 1 to key 4

Input the WEP keys. Input the prescribed number of characters as alphanumerics or a hexadecimal character string. Up to four WEP keys can be registered. Designate the registered WEP keys (1 to 4) using [Use WEP Key].

#### [Create Keys with Passphrase]

This input method is used when generating the WEP keys (key 1 to key 4) using a password.

When [OK] or [Apply] is clicked, the settings are saved or changed.

## ④ About

The software version information and MAC address of the wireless LAN mode are displayed.

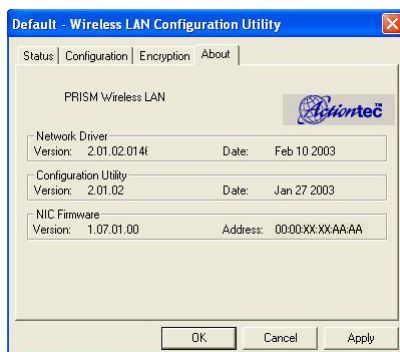
**[Network Driver]**

The network driver version information is displayed.

**[Configuration Utility]**

The configuration utility version information is displayed.

**[NIC Firmware]**

The version information and MAC address of the wireless LAN module's firmware are displayed.

## 5 When the PC is connected to the wireless network, the following message appears on the task tray:

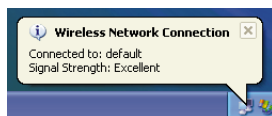

## How to shut down the wireless LAN functions

Follow the steps below to shut down the wireless LAN functions.

- 1 Press the **[Fn]** and **[F9]** keys at the same time.
- 2 The wireless LAN shutdown icon will appear on the display, and the wireless LAN indicator (●) above the **[F10]** key will go off.



- In order to conserve power, it is recommended that the wireless LAN functions be shut down when they are not in use.

## Checking the battery level

On the “Power Option Properties” screen, click the [Power Meter] tab. The current total battery level is displayed. Use the following procedure.

1. Click the [start] button and [Control Panel].
2. Click the [Performance and Maintenance] icon.
3. Click the [Power Options] icon.  
The [Power Option Properties] screen will appear.
4. Click the [Power Meter] tab.

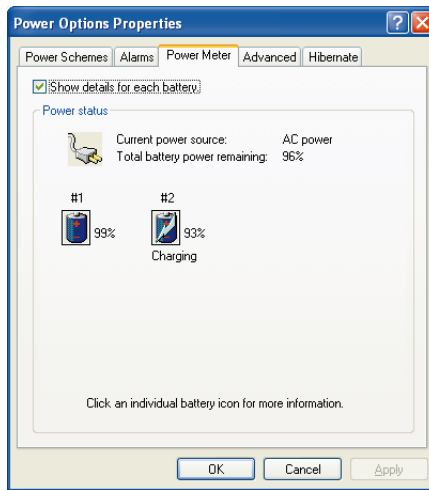

Battery gauges #1 (built-in battery) and #2 (external battery), and the total level of these two batteries are displayed.





### Important

- Battery gauge #2 (external battery) is displayed only when a standard lithium ion battery pack or large-capacity lithium ion battery pack is used.
- Note that the external battery is consumed first.

## Power-saving mode

In compliance with the operation regulations of the International Energy Star Program, this unit enters the power-saving mode when no operation is performed for a certain period.

On the [Power Schemes] tab in the “Power Option Properties” screen (page 76), you can specify the time that must expire before the unit enters the power-saving mode. The table below shows the factory settings.

	Operating on AC power	Operating on battery	Status
① Turn off monitor:	15 minutes	5 minutes	The LCD screen turns off. The  (Stand By) lamp is still lit in green.
② Turn off hard disks:	30 minutes	5 minutes	The hard disk power is turned off with the LCD screen kept off. The  (Stand By) lamp is still lit in green.
③ System standby:	20 minutes	5 minutes	The LCD screen is turned off. The  (Stand By) lamp flashes in green.
④ System hibernates:	3 hours	2 hours	The PC stores the current system status on the hard disk. The  (Stand By) lamp will go out.

### Tips

To exit status ① or ②, move the stick or press any key on the keyboard.

To exit status ③, press the Power key or any key on the keyboard.

To exit status ④, press the Power key.

### Important

- In statuses ① through ③, Windows is still running. Note that the current condition is lost if the PC is turned off by pressing the Power key for more than 4 seconds.

- **System in standby status**

The built-in battery discharges whilst the PC is in system standby status. As a result, any unsaved data may be lost or the system may not start up. Be sure to turn off the PC when it is not used for a long time.

Under fully charged condition, the unit can maintain the system standby status for the following periods.

- ① About 20 hours with the built-in battery pack alone
- ② About 55 hours with the built-in and standard battery packs

- **System in halt status**

Continued operation on the PC displaying a battery-low warning causes the result as follows:

- ① When the halt status is enabled  
The PC turns off while maintaining the current data.
- ② When the halt status is disabled  
The PC does not save the current data, which will be lost.

We recommend that you enable the halt status setting. This function is enabled at the factory.

## Unknown partition on hard disk

### **IMPORTANT!!**

This PC reserves the image data required for recovery as a “recovery area” in the hard disk. If you accidentally delete a partition of the recovery area, you cannot recover it. The important points to keep in mind are:

- DO NOT attempt to delete a hard disk area shown as an “Unknown partition” using the Windows XP “Administrative Tools”, or to assign it as another drive name.
- DO NOT attempt to delete the recovery area using specific software available in the market by initializing or changing any partition in the hard disk.

Should you delete the recovery area and ask us to re-setup your PC, you will be liable for the cost.





# **5**

## **PC RECOVERY (REPEATED PC SETUP)**

## Setting Up Your PC Again

### 1. What is the Recovery?

When you return your PC to the original state during shipment, it is called "PC recovery." You can recover your PC in one of the following two ways.

- (1) Initialize the hard disk and restore all files.
- (2) Restore the first partition of the hard disk only.

#### Cautions

Do not reduce the capacity of drive C below 11G bytes.

For details, see "Selecting the recovery method (disk partitioning)" on Page 83.

### 2. Before starting Repeated Setup

The following explains the preparation required before system recovery.

- You may not solve the problem even if you have recovered your PC. If the problem continues, consult our PC Technical Support Centre.
- You can use System Recovery on your PC only. You cannot use this software for the PC of another manufacturer.

#### Cautions

##### 1) File backup

- **If you have recovered your PC, it will have been returned to the status before shipment. All files you have created, applications you have added, and various parameters you have set will have been cleared and lost.**

Before starting system recovery, back up any important files you have created on CD-R disk or hard disk drive D of your PC.

- If you have backed up the important information in drive D, you must select the option in Step ② "Select the recovery method (disk partitioning)" on Page 83 and you must recover drive C only.

##### 2) When starting System Recovery

Detach all peripherals from your PC. If not, the recovery may stop or the required operations may differ from those written in the manual.

### 3. Repeated setup

Execute the Recovery program to restore the information on the hard disk. The Recovery program returns both your PC and all applications back to the original state before shipment. If you wish to set up the application software separately, upload them from the Application CD-ROM one at a time. (See "To Set Up the Standard Applications Again" on Page 32.)

## System Recovery Procedure

### 1. Hold down the **Alt** and **F8** keys and press the Power button to start up your PC.

When message "Do you wish to continue? (Y/N)" appears, respond with Y.

#### Tips

- If you respond with N, the recovery is canceled. The PC will restart and the Windows OS will start up.
- If too much time is taken to press the key or a continuous beep is heard for other reasons, turn off the power, and repeat the process.
- If Windows starts up after a delay, exit Windows, turn off the power, and repeat the process.

### 2. Read the License Agreement when displayed.

If you accept the Agreement, type Y.

#### Tips

If you respond with N, the recovery is canceled. The PC will restart and the Windows OS will start up.

### 3. Select the recovery method (disk partitioning).

When message "Select the recovery method (A (Recommended)/C)" appears, respond with the ① or ② key as follows.

#### ① If you respond with A:

All disk partitions and files of the hard disk are recovered, and the entire PC system is initialized to its original state.

#### ② If you respond with C:

The files of drive C are recovered and initialized.

(Usually, all data of drive D remains unaltered, as they are, and only the data of drive C is initialized. If drive D has already been removed, the PC only has drive C.)

### 4. The system recovery starts, and its progress is shown on the screen.

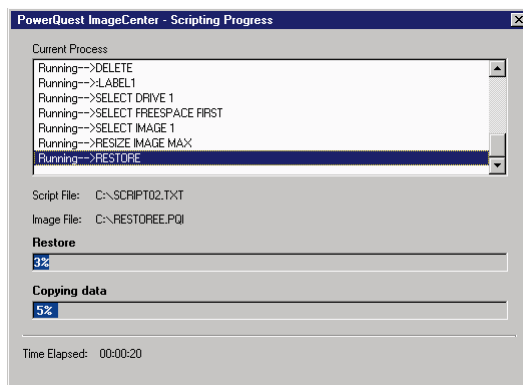

5. **After the system recovery has been completed, the message "Turn Power switch off and restart the PC." appears. Restart your PC.**  
Your PC has been returned to the original state before shipment.
6. **Set up the Windows OS by following the "Initial Setup of Microsoft Windows" procedure on Page 20.**

# 6

## TROUBLESHOOTING

## Q&A

---

There are several troubleshooting keys. If you are not sure how to operate your PC, your PC does not work well, or you suspect that your PC has been damaged, follow the relevant troubleshooting steps in the Q&A section.

### If the Q&A does not help you

#### Contact us.

If you cannot remove the trouble successfully, contact the JVC PC Technical Support Centre. See the back cover for the phone number.

### Power

#### Q. The power does not turn on.

#### A. Check the following.

- **Check that the Power key is pressed.**

Press the **⏻** (On/Off) key to turn on your PC. See “Turning **⏻**(On/Off) key On” on page 19.

#### When you are using your PC on AC power

- **Check that the AC adapter is connected.**

For connection, see “4. Recharge the built-in battery pack by plugging the AC cord into DC Input connector” on page 17.

#### When you are using your PC on the battery

- **Check that the battery is fully charged.**

For how to charge the battery, see “5. Make sure that the battery pack is fully charged” on page 18.

## Startup and Operation of Windows

### Q. The screen has hung.

#### A. Use the following procedure to forcibly exit the applications running on your PC.

##### Important

When applications are forcibly terminated through this procedure, any unsaved data will be lost.

##### Terminating an application forcibly

1. While holding down the [Ctrl] and [Alt] keys, press the [Del] key once.  
The "Windows Task Manager" screen will appear.
2. Click the [Applications] tab.
3. Click the application that hung, then [End Task]. In most cases, applications that have hung are indicated as "Not Responding."
4. When a confirmation message for terminating the application appears, click [End Now].
5. Click [x] on the Windows Task Manager screen.

##### Tips

When the application cannot be terminated, forcibly restart Windows. To restart Windows forcibly, start Windows Task Manager, click [Shut Down] on the toolbar, then click [Restart]. If your PC does not restart through the above procedure, press the RESET button on the side of the unit (page 12) or keep pressing the Power key for 4 seconds or longer to turn off the power.

##### About the message appearing if Windows is not exited normally

If you turn off the power without terminating Windows, the "Checking file system on c:" message appears at the next Windows startup, Windows and hard disk conditions will be checked, and data will be restored as necessary.

**Q. If Windows will not start**

- A.** When “Power On Self Test” is carried out at the time of power on and something wrong or out of order is detected, an error code (2 digits) is indicated on the screen, and start-up is suspended.

If you think that Windows will not start confirm whether an error code is indicated on the screen. When you ask for service, please report this error code to the service centre.

An error code may not always be indicated dependent on the cause of the trouble.

**Q. Starting the PC in the safe mode**

- A.** If some kind of trouble occurs on the PC, use the safe mode where the PC starts up with minimum functions.

Use the following procedure to start up your PC in the safe mode.

1. Turn on the PC.
2. As soon as the JVC logo appears, hold down the **[F8]** key.

**Tips**

If the **[F8]** key is pressed too late, Windows tries to make a normal startup.

Restart your PC and go back to step 2.

3. Select [Safe Mode] and press **[Enter]**.
4. Check that the operating system is selected on the “Please select the operating system to start:” screen. Press **[Enter]**.
5. When you see the “To begin, click your user name” message, click an account with which you want to start the PC in the safe mode.
6. Clicking [Yes] starts your PC in the safe mode.



## Display



### Q. The PC is turned on but nothing appears on the screen.

#### A. If the screen blacks out during operation, check the following.



- **When the  (Stand By) lamp is lit.**

- Move the stick or press any key on the keyboard to check if the power-saving function is working.

- **Check if the display is configured as an external display device.**

[While pressing , press . (Each time you do this, you can change between external display and LCD modes.)

- **To adjust the LCD display brightness:**

Pressing  and  turns the screen darker.

Pressing  and  turns the screen brighter.

- **When the  (Stand By) lamp is flashing.**

The PC is in standby mode (The power-saving mode is working).

Press the On/Off key or any key on the keyboard.

#### **Important**

Pressing the  (On/Off) key for more than 4 seconds terminates Windows forcibly, discarding the unsaved data.

- **When the  (Stand By) lamp is not lit.**

The PC is turned off. Press the  (On/Off) key to turn on your PC.

## Using the Internet

### Q. I cannot dial up.

#### A. Check the connection.

- **Check that the modem cable is connected.**

If you see the “There was no dial tone.” message, check the connection between the unit and the telephone line connector on the wall. Insert the modem fully until it is locked.

- **When a divider is used**

Connect the modem cable directly to the phone jack for checking.

- **When you are connecting via an ISDN line**

Check that the terminal adapter is ready.

For details, refer to the instruction manual for your terminal adapter.

- **Check that the modem is recognized properly.**

1. Click the [start] button and [Control Panel].
2. Click the [Printers and Other Hardware] icon.
3. Click the [Phone and Modem Options] icon, then the [Modems] tab.
4. Select the modem by clicking it, click [Properties], then the [Diagnostics] tab.
5. Click [Query Modem].

When the modem is recognized properly, the inquiry command and response to it will be displayed.

#### **Important**

If the modem is not recognized properly, check if it conflicts with any other device.

If the modem device is displayed with a “!” mark on the Device Manager screen, it may conflict with another device.

**Q. The PC dials but connection is not established.****A. Check the dialing setting.**

- **Check that the dialing type (tone or pulse) is correctly set for your telephone line.**  
For checking and configuration procedures, see “3. Setting up the modem” on page 36.
  
- **When no connection operation occurs, check the destination setting.**  
Use the following procedure to check the setting for connecting to your Internet Service Provider (ISP) or network.
  1. Click the [start] button and [Control Panel].
  2. Click the [Network and Internet Connections] icon.
  3. Click the [Network Connections] icon.
  4. Right-click the icon for the destination of connection to bring up a pop-up menu. Click [Properties] in the menu.
  5. Check the setting according to the instruction manual provided from your ISP.
    - On the [General] tab, check the “Connect using” and “Phone number” settings.

**Tips**

Some ISPs have different phone numbers for access points via ISDN lines from those for points via ordinary lines. Contact your ISP for details.

- For how to check and set the DNS server addresses (primary DNS and secondary DNS), see DNS server address setting procedure (10-20) on pages 40 and 41.

**Important**

If your ISP specifies no DNS server address, click [Obtain DNS server address automatically].

**Q. The PC makes a connection operation but connection is not established.**

**A. Check the following.**

- **Check the user name and password.**

Refer to the material sent from your ISP for correct user name and password.

- **The internal modem dials but negotiation is not made.**

The access point may have a problem. Try to establish a connection later. If this attempt fails, use a different access point.

- **Advice when using the internal modem**

If “Max Battery” or “Presentation” has been selected for “Power Options” in the “Power Options”/“Power Schemes” tab from [Power Option Properties] and the battery is being used to power the PC, this may cause the internal modem to slow down its speed of communication or fail to dial up, depending on the condition of the telephone line. In cases like this, change to a setting other than “Max Battery” or “Presentation” (such as “Portable/Laptop”).

**Q. The PC cannot send or receive e-mail messages.**

**A. If you are using the Outlook Express software, check the e-mail software settings.**

If you are using any other mailer than Outlook Express, refer to the pertinent instruction manual or help.

1. Start Outlook Express.

#### **Tips**

If the “Dial-up Connection” screen appears, click [Work Offline] or the [x] button.

2. Click [Tools] on the tool bar (at the top of the screen). Click [Accounts] on the Tools menu.
3. Click the [Mail] tab.
4. Click an account and [Properties].
5. Click the tabs to check that the entries are correct.

#### **Important**

Use lower-case letters only.

## Wireless LAN (MP-XP7230GB only)

### Q. I can't communicate.

#### A. Check the following.

- **Is the device serving as the other end of the communication the kind of device which can communicate with the PC?**

A number of communication systems can be used with the wireless LAN, but unless the same system is used at both ends, communication will not be possible.

- **Has the security been set correctly?**

Select the same setting for the network key (WEP encryption) of this PC's wireless LAN as the one used by the access point.

- **Has the IP address been set correctly?**

Check whether the IP address been set correctly by taking step 2 (Set the IP address used with the wireless LAN) on page 69 in the section entitled "Network connections using a wireless LAN."

- **If the wireless LAN cannot be set to ON or OFF**

When the PC has been re-started after termination caused by an error, the wireless LAN may remain inoperable. In a case like this, shut down the PC and then start it up again.

### Q. The communication speed is slow.

- #### A.
- Check the distance between the PC and the other end of the communication. In some cases, the communication speed varies depending on the distance involved.

### Q. I can't share with other computers on the network.

- #### A.
- If no other computers appear on "Local Network" selected from "My Network Places," establish the same "Workgroup" or "Domain" setting.

**Q. How can I check the MAC address?****A.** Proceed as follows to check the MAC address of the PC's wireless LAN.

\* In order to check the MAC address, the wireless network connection must first be set using [Network Connections].

1. Click the [Start] menu, and click [Control Panel].
2. Click the [Network and Internet Connections] icon.
3. Click the [Network Connections] icon.
4. Check that [Wireless Network Connections] is enabled.
5. Double-click [Wireless Network Connections].  
The "Wireless Network Connection Status" screen appears.
6. Click the [Support] tab, and click the [Details] button.  
The [Network Connection Details] screen appears.
7. The value for "Physical address" displayed on the list indicates the MAC address.

**Battery****Q. The battery is not charged.****A. Check the following.****• When the built-in battery cannot be charged**

This PC is shipped with a short-circuiting pin on the standard lithium ion battery pack terminal. Be sure to remove the pin before use.

For removal, see "Mounting/Dismounting the Lithium Ion Battery Pack" on page 16.

**• When the standard lithium ion battery pack cannot be charged**

For how to mount the standard lithium ion battery pack, see "Mounting/Dismounting the Lithium Ion Battery Pack" on page 16.

If you are still unable to charge the battery pack, check the following.

Check that the AC adapter is connected correctly to an appropriate power socket and the PC unit.

For connection, see "4. Recharge the built-in battery pack by plugging the AC cord into DC Input connector" on page 17.

**Q. Battery discharge faster than expected****A. This device continues to supply DC current to the USB port in standby in order to respond to the wake-up signals from some USB peripherals.**

If you keep this device in standby for long time with just battery power, please remove peripherals from the USB port.

## SD memory cards

**Q. The “Not formatted” or “Not initialized” error message appears when I insert an SD card, CF card or other memory card with a memory capacity exceeding 32MB into a digital camera or other device even though the card has been formatted, and I cannot use the card.**

**A.** To format an SD card, CF card or other memory card with a memory capacity exceeding 32MB in this PC, the “FAT” file system rather than the “FAT32” file system must be selected on the Windows XP formatting screen. By formatting cards in this way, they can be used with digital cameras and other such devices.

\* When a memory card is to be formatted, be absolutely sure to first back up its contents onto the PC’s hard disk, etc. When formatting is executed, all the information stored on the card will be erased.

## Concerning the USB port

**Q. The moving pictures or sound breaks up when capturing moving pictures or transferring high-speed data from a DVC or other device using the USB port.**

**A.** If a device complying with the USB 1.1 Full Speed standard is used while the internal wireless LAN is being used, connect to the USB port at the back of the PC for use. If the PC’s internal wireless LAN and front USB port are used at the same time, the USB may not be able to perform to the best of its ability.

## Miscellaneous

### Q. The PC is hot.

#### A. The PC may become warm when used for a long time, but this is not a failure.

Do not block the vents in the bottom or sides through which internal heat is removed.

### Q. The PC makes no sound.

#### A. Check the following

- **Check if the speaker is muted.**

To use the volume control, press **[Fn]** and **[F7]**.

(This key combination turns on and off the volume control.)

Pressing **[Fn]** and **[F5]** turns down the volume.

Pressing **[Fn]** and **[F6]** turns up the volume.

### Q. I forgot the password.

#### A. If you forgot your password, you cannot start the PC again.

Whenever you set a password, be careful not to forget it.

- **If you forget the user account (computer administrator) password**

- 1. When a password deleting disk has been prepared**

You can delete the password using the disk. For how to prepare a password deleting disk, see "Help and Support Centre" from the [start] menu.

- 2. When another computer administrator account has been created**

If an additional computer administrator (a user who has the administrator rights) is created other than the user who forgot the password, log on to the computer as the administrator to change the password.

- 3. When no computer administrator account has been created**

When no administrator password is set, you can change the forgotten user password by starting up Windows in the safe mode and logging on as an administrator.

\* If any of the above does not solve the problem, you must restore the factory setting. For procedure for setting up Windows again, see "Setting Up Your PC Again" on page 82.



- **If you forget the BIOS password**

**The following passwords can be set on the BIOS.**

- User password

When this password is set, the user is requested to enter the password to start Windows or change a BIOS setting.

- HDD password

The password required for accessing the hard disk.

**Important**

- You cannot delete the BIOS password even if you forget it. To delete it forcibly, you have to return your PC to us for chargeable service. (It may require hard disk drive replacement.)

- To bring up the BIOS menu, turn on the PC and press the **[Alt]** and **[F2]** keys while the JVC logo screen is shown.

Do not change the BIOS setting unless you have adequate knowledge of computers. A wrong setting can make your PC unable to start up again or, worse, damage it.

**Q. Setting procedure does not complete.**

**A. If Internet, e-mail, or any other setting does not complete through the procedure described in this manual, check the following.**

- If the [Control Panel] display is in Classical mode, change it to the Category mode. All the setting procedures in this manual assume the Category display mode.





# APPENDIX

## List of Support Centres

1. ImageMixer with VCD 1.1 VJ

<http://www.imagemixer.com>

2. Norton AntiVirus 2003

<http://www.symantec.com/region/reg-eu/techsupp/index.html>

3. RealPlayer 8 Basic

<http://www.service.real.com>

4. Pinnacle Studio 8 SE

<http://www.pinnaclesys.com>

## Trademark notice

1. i.LINK refers to IEEE1394-1995 and their expanded specifications. i.LINK and the i.LINK logo are trademarks of Sony Corporation, devised to make people more familiar with IEEE 1394.
2. Microsoft, Windows, Windows Media are trademarks or registered trademarks of Microsoft Corporation in the U.S. and other countries. The official name for Windows is Microsoft Windows Operating System.
3. RealPlayer is a registered trademark or pending trademark of RealNetworks, Inc. in the U.S. and other countries.
4. Adobe, the Adobe logo, and Adobe Acrobat are trademarks of Adobe Systems Incorporated.
5. Symantec, the Symantec logo, and product names are trademarks or registered trademarks of Symantec Corporation in the U.S. and other countries.
6. Symantec, the Symantec logo, and Norton AntiVirus are registered trademarks of Symantec Corporation in the U.S.
7. The SD logo is a registered trademark.
8. CC Converter and the CC Converter logo are trademarks.
9. The Pinnacle System Inc. logo and product names are registered trademarks of Pinnacle System Inc. in the U.S.
10. Other system, product, and service names may be trademarks or registered trademarks of respective developers.

## Specification

Model Name		MP-XP7230GB	MP-XP5230GB
OS		Windows <sup>®</sup> XP Professional	Windows <sup>®</sup> XP Professional
CPU	Model	Mobile Intel <sup>®</sup> Pentium <sup>®</sup> III processor-M	
	Clock speed	933MHz	
Bus clock speed		133MHz	
Secondary cache memory		512KB	
Main memory		256MB, standard (128MB on-board)/384MB, max.	128MB, standard (128MB on-board)/384MB, max.
Extended memory slot (available slot)		Memory slot x 1 (0)	Memory slot x 1 (1)
Hard disk <sup>*1</sup>		30GB	20GB
Graphic accelerator		Built-in SiS630ST	
Video memory		16MB shared with main memory (max. 64MB)	
Built-in monitor	Screen size	8.9-type low-temperature polysilicon TFT liquid crystal (with backlight) <sup>*8</sup>	
	LCD screen (machine body)	1024 x 600 dots, 16.77 million colours	
External monitors <sup>*2</sup>		640*480, 800*600, 1024*600, 1024*768 <sup>*3</sup> , 1280*1024 <sup>*3</sup> , 1600*1200 <sup>*3</sup> 16.77 million colors	
Sound		Compatible with Sound Blaster Pro <sup>™</sup> , built-in stereo speakers	
Built-in fax/modem		Max. transmission speed: 56kbps (data receive), 33.6kbps (data send), 14.4 kbps (fax) Compliant with V.90/K556flex <sup>™</sup> standard (auto-change)	
Interfaces		External monitor outputs <sup>*2</sup>	
		Modem jack (RJ-11) x 1	
		Wireless LAN (in accordance to IEEE 802.11b) x 1 (MP-XP7230GB only)	
		USB(2.0) x 2 <sup>*4</sup>	
		iLINK (IEEE1394) 4-pin S400 x 1 <sup>*5</sup>	
		LAN connector (10/100BASE-TX) x 1	
		MIC IN (mini-jack mono) x 1	
		Headphone OUT (mini-jack stereo) x 1	
		Type-II PC-card slot x 1 (compatible with CardBus)	
		SD memory card slot x 1	
Keyboard	Key pitch	16mm	
	Key stroke	1.5mm	
Pointing device		Stick type	
Power supply		AC adapter or lithium ion battery packs	
Power consumption		Max. 46W	
Battery operation <sup>*6</sup>	Built-in battery	Approx. 2.0 hours (approx. 1.6 hours by JEITA 1.0)	Approx. 2.2 hours (approx. 1.8 hours by JEITA 1.0)
	Built-in battery + standard battery pack	Approx. 5.5 hours (approx. 4.5 hours by JEITA 1.0)	Approx. 6.0 hours (approx. 5.0 hours by JEITA 1.0)
	Built-in battery + Large battery pack	Approx. 9.0 hours (approx. 7.5 hours by JEITA 1.0)	Approx. 10.0 hours (approx. 8.0 hours by JEITA 1.0)
Battery charging time (OFF times) <sup>*7</sup>		Built-in battery: Approx. 1.0 hours (80%), 1.5 hours (100%) Standard battery pack: Approx. 1.3 hours (80%), 2.3 hours (100%) Large battery pack: Approx. 2.0 hours (80%), 3.0 hours (100%)	
Dimension		225 mm (W) x 28.0 mm (H)(29.5 mm with battery pack installed) x 152 mm (D)	
Dimension with standard battery pack installed		225 mm (W) x 28.0 mm (H)(29.5 mm with battery pack installed) x 177 mm (D)	
Dimension with large battery pack installed		225 mm (W) x 28.0 mm (H)(32.5 mm with battery pack installed) x 197 mm (D)	
Weight		Approx. 905 g	Approx. 880 g
Weight with battery pack installed <sup>*9</sup>		Approx. 1245 g	Approx. 1050 g

\*1 For partitions, approximately 5GB are assigned to D and the rest is assigned to C.

\*2 The connection to an external monitor requires the optional external display signal cable (MP-VGX1E).

\*3 Displayed on an external monitor only.

\*4 Not all operations of USB-support devices are guaranteed.

\*5 Not all operations of iLINK-support devices are guaranteed.

\*6 The battery operation times are those values measured in the power saving mode; they may change depending on your setup or usage.

\*7 The battery recharge starts with the built-in battery or external battery pack, whichever has less remaining power.

\*8 The LCD screen is made with high-precision technology. However, black points or bright points may appear constantly on the LCD screen. In addition, change in temperature may result in mottled colors. This is due to the LCD-specific structure, not a malfunction.

\*9 The MP-XP7230GP comes with a large battery pack, and the MP-XP5230GP comes with a standard battery pack.

## Wireless LAN specifications (MP-XP7230GB only)

Wireless frequency band	2412 to 2472 MHz (all 13 channels)			
Modulation system	DSS (Direct Spread Spectrum system) CCK (communication speed: 5.5 Mbps, 11 Mbps) DQPSK (communication speed: 2 Mbps) DBPSK (communication speed: 1 Mbps)			
Spread spectrum system	11-chip Barker sequence			
Rated output	15 dBm			
Communication speed	11 Mbps	5.5 Mbps	2 Mbps	1 Mbps
Reception sensitivity	-84 dBm	-87 dBm	-90 dBm	-90 dBm
Spread delay (under FER 1%)	81ns	164ns	290ns	290ns
Communication distance	Recommended communication distance between PC and device serving as other end of communication: 25 metres indoors			

**Note:** There is a correlation between the communication distance of a wireless device and its communication speed: The lower the communication speed of the wireless communication, the further the communication distance. Furthermore, the communication distance is susceptible to the effects of the ambient environment, and it may be reduced in the following cases.

- Inside condominiums and other reinforced concrete structures, houses in which metal is used in the building construction materials
- Near large pieces of furniture, etc. made of metal

**Options (separately available)**

Option name	Model
CD-ROM drive *1	MP-CDX1E
Standard lithium ion battery pack *2	BN-LS12E
Large-capacity lithium ion battery pack *3	BN-LL21E
Battery charger *4	MP-BCX1E
AC adapter *2	MP-ACX1GB
External display cable	MP-VGX1E

- \*1 Connected with a PC card and powered from the Mobile mini note PC. Maximum read speed is 16x.
- \*2 Same items as those supplied with the product.
- \*3 Enables 9 hours of continuous operation when used with the built-in battery. It comes with a carrying case.
- \*4 High-speed battery charger. It supplies power to the Mobile mini note PC and charges the built-in battery pack while charging an external battery pack.





# JVC

VICTOR COMPANY OF JAPAN, LIMITED

## CE 0197 ⓘ

- This equipment with RLAN is intended to be used in Germany, UK, Austria and Switzerland.  
Outdoor use may be restricted to certain frequencies and/or may require a licence for operation.
- The built-in V.90 modem is installed for use on official analog telephone lines in Germany, UK, Austria, France and Switzerland.

## How you can use the built-in wireless LAN even more easily

You can reduce the wireless LAN connection time by using the accessory utility. The Instructions of this PC are written on the assumption that this accessory utility will be used.

The utility can be used by taking the following steps.



- ① Double-click the [Wireless Network Connections]

icon  on the task tray. Click the [Advanced...] button on the [Wireless Network Connections] screen.

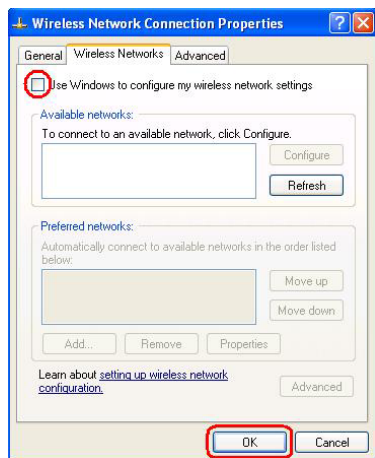



- ② The [Wireless Network Connection Properties] screen will appear. Remove the check mark for [Use Windows to configure my wireless network settings], and click [OK].

- ③ Restart the PC.



When the wireless LAN status icon on the task tray is double-clicked, the main menu of the accessory setting utility is opened, enabling the wireless LAN status to be checked or set. For details on how to set the wireless network, refer to pages 71 and following in the Instructions.

## Supplementary instructions for using internal wireless LAN

If the wireless network connection has been disabled, the wireless LAN status icon  and the wireless network icon  may not appear on the taskbar. The wireless LAN ON/OFF hot keys (**[Fn] + [F9]**) will not work, either. When the wireless LAN is to be used in a situation like this, the wireless network connection must be enabled. Take the following steps to enable the wireless network connection.

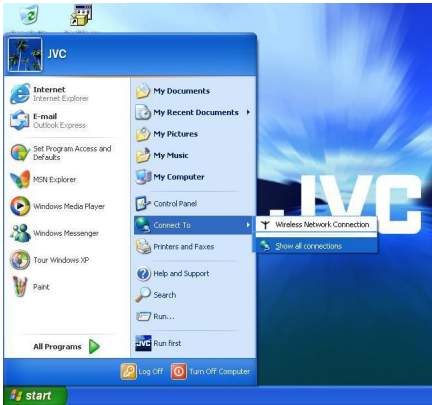

- ① Click [Start], and select [Show All Connections] from [Connect to].

If [Connect to] fails to appear on the start menu, double-click the [Network Connections] icon on the control panel to open the [Network Connections] window.

- ② Select [Wireless Network Connections] on the [Network Connections] window, select [Enable] on the [File] menu, and then restart the PC.

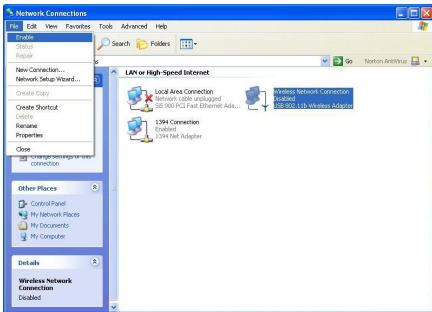

- ③ The wireless LAN status icon and wireless network icon will now appear on the taskbar, and the wireless LAN is ready to use.



# JVC



## USB Port Replicator

---

# MP-PRX1GB

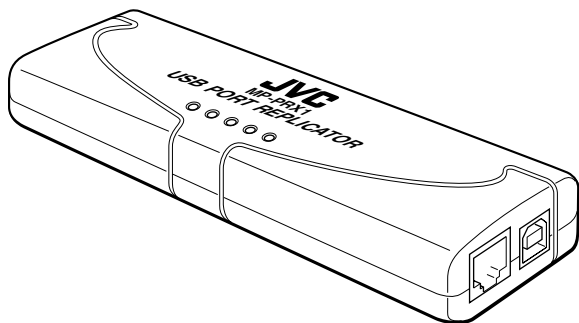

## INSTRUCTIONS

Thank you for purchasing the JVC MP-PRX1GB USB Port Replicator.

### **Before Use**

Read and follow the instructions of this manual to use your USB Port Replicator.

Always read the "Safety Instructions". Keep this manual for further reference.

LET0238-001A

**Dear Customer,**

Thank you for purchasing the JVC USB Port Replicator. This unit is to be used with JVC AC Adapter AA-E5025GB. To avoid problems and obtain the best results, please read this instruction booklet carefully before use.

**WARNING:**

**TO PREVENT FIRE OR SHOCK HAZARD, DO NOT EXPOSE THIS UNIT TO RAIN OR MOISTURE.**

**CAUTION:**

To prevent electric shock, do not open the cabinet. No user serviceable parts inside. Refer servicing to qualified service personnel.

**NOTE:**

The rating plate (Serial number plate) is on the bottom of the unit.

When the equipment is installed in a cabinet or on a shelf, make sure that it has sufficient space on all sides to allow for ventilation (10 cm or more on both sides, on top and at the rear).

Do not block the ventilation holes.

(If the ventilation holes are blocked by a newspaper, or cloth etc. the heat may not be able to get out.)

Do not allow the USB Port Replicator or AC adapter to operate with the base resting directly on your laps and others. Allowing sustained contact with may cause discomfort or, eventually, aburn.

No naked flame sources, such as lighted candles, should be placed on the apparatus.

The apparatus shall not be exposed to dripping or splashing.

Do not use this equipment in a bathroom or places with water.

Also do not place any containers filled with water or liquids (such as cosmetics or medicines, flower vases, potted plants, cups etc.) on top of this unit.

(If water or liquid is allowed to enter this equipment, fire or electric shock may be caused.)

**CAUTIONS:**

- If used near a radio, this unit may interfere with reception.
- Prevent inflammables, water and metallic objects from entering the unit.
- Do not disassemble or modify the unit.
- Do not apply shocks to the unit.
- Do not subject the unit to direct sunlight.
- Avoid using the unit in extremely hot or humid places.
- Avoid using the unit in places subject to vibrations.

This USB Port Replicator is for use exclusively with JVC Mobile mini note PC.

## Introduction

This USB Port Replicator is a unique expansion unit specially designed to complement the Notebook Computer and make it equivalent in many ways to a desktop PC. It provides some of the connection functions found on a desktop system.

The USB Port Replicator allows you to add multiple high-performance USB 2.0 peripheral devices to your PC. Moreover, this product is fully backward compatible with the USB Revision 1.1 products, which means your previous USB 1.1 devices will continue to function as well. There are no complex installation, confusing cables, plug-ins or IRQ's (Interrupt request) to worry about. Now, you can simply plug and play all of your peripherals without re-booting your PC.

## Features

- Compliant with Universal Serial Bus Specification Revision 2.0
- Data transfer rate up to 480 Mbps
- Two USB 2.0 downstream ports
- PS/2 keyboard port
- PS/2 mouse port
- USB file transfer data link port
- Serial port
- Printer port
- Standard IEEE-1284 parallel port
- The USB Port Replicator uses USB bus power and self power.  
(Depending on the devices connected, it may not work unless the AC adapter is used.)
- 10/100 Ethernet LAN port

## Package Contents

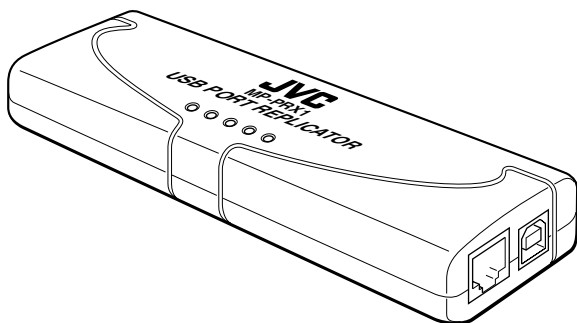

USB Port Replicator

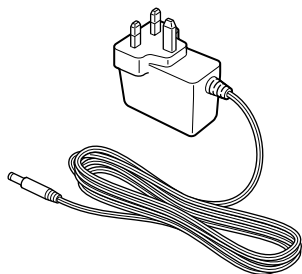

AA-E5025GB AC Power Adapter

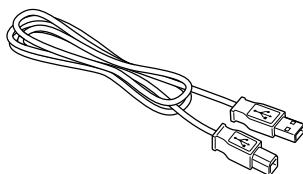

USB Cable (1.8 meters long)

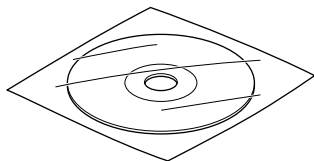

Software CD-ROM

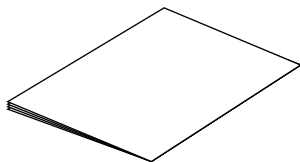

Instruction Manual (this booklet)

## Hardware Installation

### LED Status Indicators

LED	Color	Descriptions
POWER	Red	Indicates that the power is on.
2 PORT HUB	Green	Indicates that both USB 2.0 ports are now ready and active.
LAN (10/100)	Green	Indicates a data transfer rate of up to 100 Mbps.
LAN (LINK)	Green	Indicates that an external device is connected to the LAN port and is ready to communicate.

Figure 1: LED

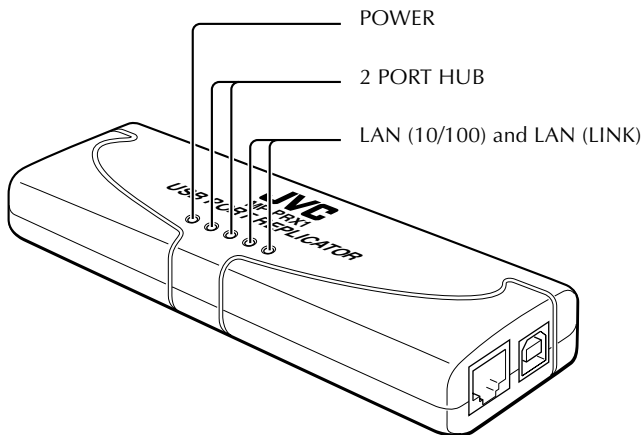



## Connection to Mobile Mini Note PC

Figure 2: Connection to Mobile mini note PC

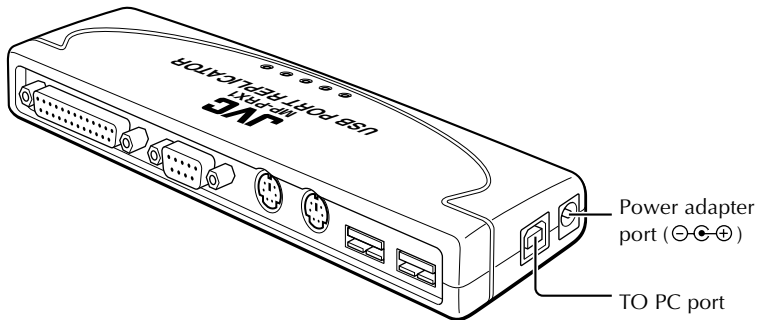

- Insert the jack of the AC adapter into the power adapter port (⊖ ⊕ ⊕).
- Connect the TO PC port to the Mobile mini note PC using the USB cable.
- In the case of the Mobile mini note PC MP-XP7210GB/XP5230GB/XP3210GB, Windows will automatically find the USB Port Replicator at this point and start installing the drivers for the USB Port Replicator. Windows will prompt you to install the Software CD-ROM. See the 'Software Installation' section for details on how to install the software.
- In the case of the Mobile mini note PC MP-XP7230GB, the drivers for the USB Port Replicator have already been installed and the port replicator is ready to be used.

## Other I/O Ports

Figure 3: Other I/O ports

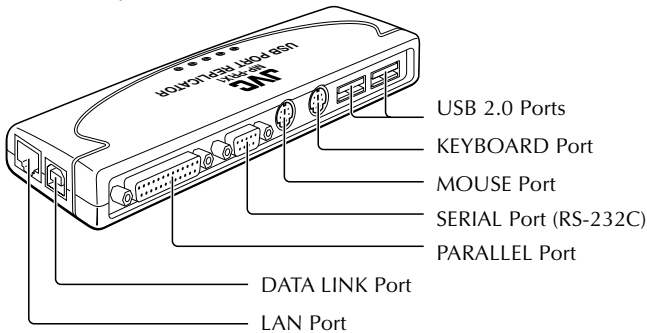

### USB 2.0 Ports

Before connecting a USB 2.0 device to one of the USB 2.0 ports, refer to the Software Installation section of this Instruction Manual.

### PS/2 KEYBOARD and MOUSE Ports

If you connect an IBM PC compatible PS/2 standard keyboard or mouse to the USB Port Replicator, Windows will automatically install the driver without the CD-ROM. Otherwise, you will need to follow the driver installation guide that came with the keyboard or mouse.

### DATA LINK Port (Purchase separately the cable that is to be connected to this port.)

You need a Type A to Type B USB cable for connecting two PCs. This port supports the software drivers for Windows XP and for the Windows installer, access the root directory of the Software CD-ROM. You need the PC-Linq Software CD-ROM to enable this DATA LINK port. Refer to help the instructions for how to install the PC-Linq Software.

### SERIAL Port

This serial port is not a plug and play interface.

### PARALLEL Port

You can attach your computer to almost any parallel printer device through this port for faster printing.

### LAN Port

This port supports the Ethernet 10/100 Mbps function. It is a USB 2.0 to fast Ethernet adapter integrated with a USB 2.0 bus Ethernet controller for high performance functionality. It is compliant with the IEEE 802.3/IEEE802.3u LAN standard.

## Software Installation

### STEP 1

Connect the CD-ROM drive to the Mobile mini note PC and turn it on. Insert the Software CD-ROM. Supply power to USB Port Replicator using AC power adapter. Connect the Mobile mini note PC and the USB Port Replicator using the High-Speed Cable (USB cable) included with this port replicator.

### STEP 2

The Mobile mini note PC finds the GWU2E (USB 2.0 10/100 Base Ethernet Adapter) device of the USB Port Replicator.



Select **“Install the software automatically [Recommended]”**.  
Click **Next** to continue.



Click **“Continue Anyway”** to continue.



The wizard has finished installing the software. Click **Finish** to continue.

### STEP 3

The Mobile mini note PC finds the USB Bridge Cable (USB device) of the USB Port Replicator.



This wizard helps you install the device driver.

Select "**Install the software automatically [Recommended]**".

Click **Next** to continue.



The wizard has finished installing the software. Click **Finish** to continue.

#### STEP 4

Next the PC-Linq Software is installed to enable the data link connection between the Mobile mini note PC and other external PC via the USB file transfer data link port (DATA LINK port).

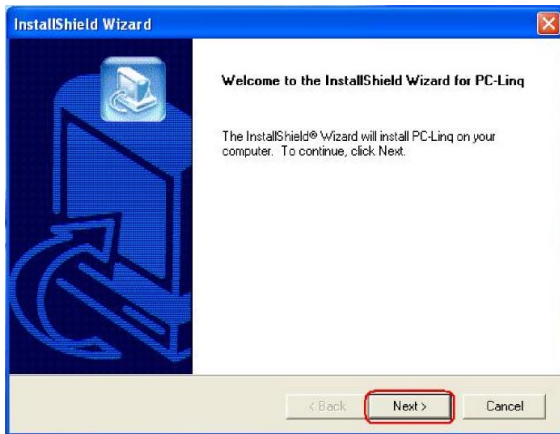

The **"Welcome to the Install Shield Wizard for PC-linq"** dialog window appears. Click **Next** to continue.

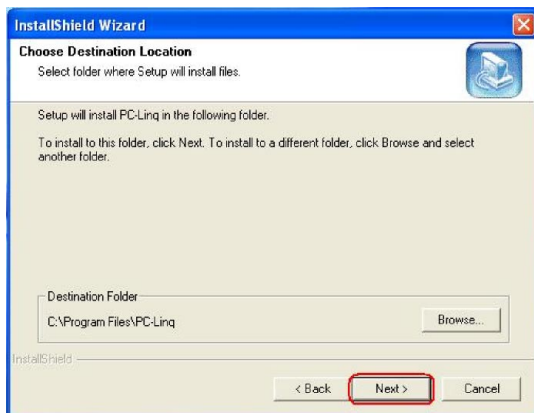

Click **Next** to continue.



Setup will add the program icon to the Program Folder.  
 You may type a new folder name or select the default folder name.  
 Click **Next** to continue.

The PC-Linq icon  will appear on the desktop.

• **Support Center PC-Linq software and driver**  
[http://www.goodway.com.tw/shop/online\\_service.asp](http://www.goodway.com.tw/shop/online_service.asp)

**STEP 5**

The Mobile mini note PC finds the Prolific USB-to-Serial Comm Port of the USB Port Replicator.



This wizard helps you install the device driver.  
Select **“Install the software automatically [Recommended]”**.  
Click **Next** to continue.



The wizard has finished installing the software. Click **Finish** to continue.

**STEP 6**

## Installation Verification

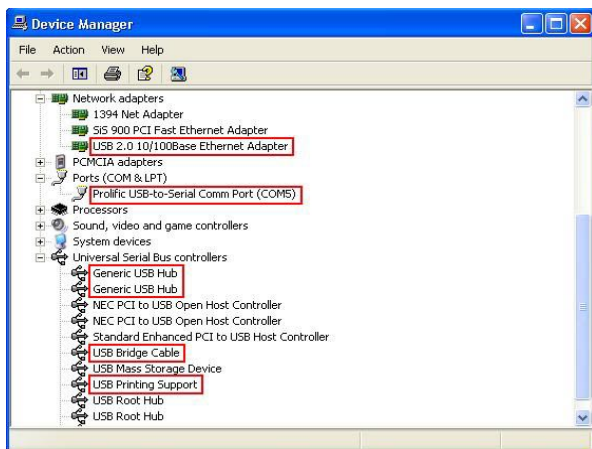



## Appendix:

### Installing the PC-Linq Software and Driver in an External PC

If you connect an external PC to the Mobile mini note PC via the DATA LINK port of the USB Port Replicator, you must install the PC-Linq software and driver on the external PC as well as instructed below.

#### STEP 1A

Start the PC you want to connect to.

Insert the software CD-ROM into the CD-ROM driver of the PC you have just started.

#### STEP 2A

Supply power to USB Port Replicator using the AC power adapter. Then connect the external PC to the DATA LINK port of the USB Port Replicator using the USB cable.

#### STEP 3A

The external PC finds the USB Bridge Cable (USB device) of the USB Port Replicator.



This wizard helps you install the device driver.

Select **“Install the software automatically [Recommended]”**.

Click **Next** to continue.



The wizard has finished installing the software.  
Click **Finish** to continue.

#### STEP 4A

The PC-Linq Software is now installed.



The “**Welcome to the Install Shield Wizard for PC-Linq**” dialog window appears.  
Click **Next** to continue.

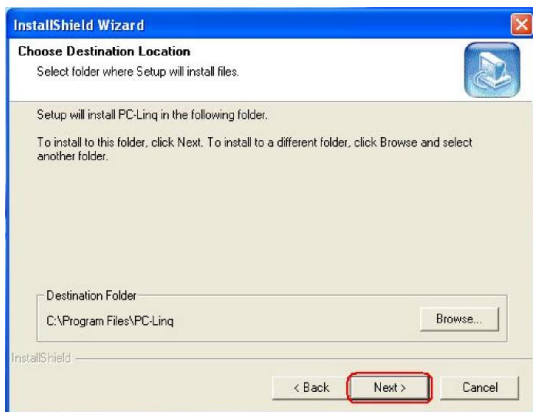

Click **Next** to continue.



Setup will add the program icon to the Program Folder.  
You may type a new folder name or select the default folder name.  
Click **Next** to continue.

The PC-Linq icon  will appear on the desktop of the external PC.

- **Support Center PC-Linq software and driver**  
[http://www.goodway.com.tw/shop/online\\_service.asp](http://www.goodway.com.tw/shop/online_service.asp)

## Specifications

Computer Port	TO PC port (Upstream port) Type B receptacle
I/O Ports	2 USB 2.0 ports Type A receptacles
	PS/2 KEYBOARD port Mini Din 6 pin
	PS/2 MOUSE port Mini Din 6 pin
	DATA LINK port Type B receptacle
	SERIAL port DB 9 pin male
	PARALLEL port DB 25 pin female
	10/100Base-T LAN port 8P8C RJ45 shielding
Power	DC Input 5V, 2.5A
Dimensions	178.0 (W) x 25.9 (H) x 55.5 (D) mm
Weight	Approx. 151g
Environment	Operating temperature: 5°C -35°C Storage temperature: 0°C - 40°C Humidity: 85 %RH (No condensation)



# JVC

VICTOR COMPANY OF JAPAN, LIMITED

CE



## Setting Up of USB Port Replicator (MP-PRX1GB)

### Installing the device driver

#### Note

- Log on to the computer using user with administrator privilege to install.
- If the setting for "Driver Signing Options" is set to "Block", then the device driver cannot be installed. Change the "Driver Signing Options" settings.

#### 1. Turn the PC's power on.

#### 2. Connect this unit to the PC.

The unit's power is automatically turned on, and the **POWER Indicator lamp** turns green.

[Welcome to the Found New Hardware Wizard] screen is displayed.

#### 3. Check the drive display.

GWU2E

#### 4. Select [Install from a list or specific location] and click [Next].

[Please choose your search and installation options] is displayed.

#### 5. Select [Search for the best driver in these locations].

#### 6. Select [Include this location in the search] and enter C:\Drivers\PR and click [Next].

#### 7. [Hardware Installation] screen is displayed. Confirm the displayed drive and click [Continue Anyway].

Message "The software you are installing for this hardware...has not passed Windows Logo testing to verify its compalibility with Windows XP" is displayed, however, this does not affect operation.

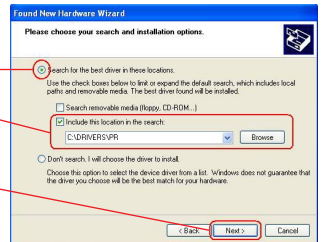

#### 8. The device driver is installed and the [Completing the Found New Hardware Wizard] is displayed. Click [Finish].

